

KAS®

Evinizin her yerindeyiz!

www.kas.com.tr



2022-01 Fiyat Listesi

► Vana ► Kollektör ► Flex ► PPRC ► Armatür

[f](#) [t](#) [y](#) [i](#) / kas grup

Dünya'da 100'den fazla ülkede,
aynı statüye sahip firmalarla

"Uluslararası Güvenli Ticaret Ağı"

oluşturmamıza imkan sağlayacak,

Yetkilendirilmiş Yükümlü Sertifikamızı Aldık.

TÜRKİYE CUMHURİYETİ
TİCARET BAKANLIĞI



Yetkilendirilmiş Yükümlü Sertifikası
Kayalar Pres Döküm San. Tic. Ltd. Şti.

Bu belge, 4458 sayılı Gümrük Kanununun 5/A maddesine
istinaden yukarıda unvanı kayıtlı kişi adına,
yetkilendirilmiş yükümlü statüsünün sağladığı hak ve
kolaylıklardan yararlandırılmak üzere düzenlenmiştir.

Sertifika No: TR/AEO7.20340026



Ad Soyad *Yalçın Özdemir*
Unvan *İstanbul Gümrük ve Dış Ticaret
Bölge Müdürü*

KAS



**Sizlere sunduğumuz kaliteden
hiçbir zaman ödün vermeyiz.**

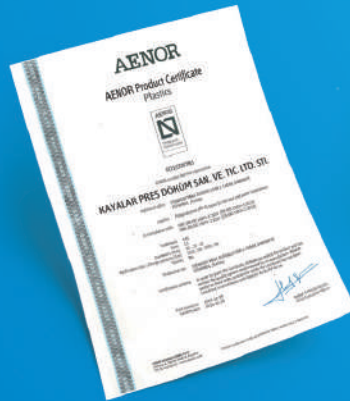
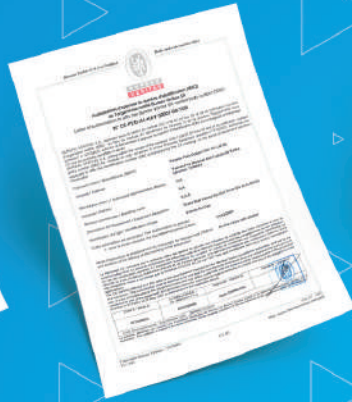

Kayalar Grup

Kayalar Grup, üretim faaliyetlerine 1970 yılında başlamış, sonrasında, kurulan Kayalar Pres Ltd. Şti. altında pirinçten mamül parça ve fittings üretimine devam ederek 1994 yılında KAS markasını tescil ettirmiş, böylece radyatör vanası ve pirinç rakor üretimini kendi markası ile piyasaya sunmaya başlamıştır. 1999 yılında İstanbul Sancaktepe’de bulunan ve bu gün 12.000 m² kapalı alana sahip üretim tesisine yerleşerek ürün çeşidini ve üretim kapasitesini artırmıştır. Pazarlama ve satış faaliyetlerinin ayrı bir organizasyon altında yapılabilmesi amacıyla da 2000 yılında KASPA Dış Tic. A.Ş. Grubun bünyesinde faaliyetlerine başlamıştır . Kayalar Grup, büyüme stratejisi doğrultusunda paslanmaz flex hortum imalatına başlanmış ve bu amaçla 2004 yılında Kayalar Armatür A.Ş. şirketini kurmuştur. Son olarak 2007 yılında elektronik cihazlar üretmek amacıyla KAS Sismik Elektrik-Elektronik A.Ş. kurulmuş ve elektro-mekanik deprem cihazı üretimine girilmiştir. Üretim faaliyetlerindeki 40. yılında Kayalar Grup, bünyesinde bulunan dört şirketi , üç farklı üretim tesisi ile toplamda 15.000 m² kapalı alanı, konusunda bilgili ve deneyimli Ar-Ge üretim ve pazarlama ekipleri ile sektörün en köklü kuruluşlarından birisi olup rekabet avantajını sürdürebilmek için sürekli büyümekte ve gelişmektedir.

Alanında birçok yeniliğe öncülük eden Kayalar Grup 2010 yılı itibarı ile 300’e yakın ürün grubunda 600’ü aşkın ürün çeşidi ile müşterilerine hizmet vermektedir. Sektöründe doğalgaz, içme suyu, yangın tesisatları ile inşaat ve sanayide kullanılan birçok teknik ürünü müşterilerine sunan ve kaliteyi müşterisinin en temel hakkı olarak gören Kayalar Grup TSE, TS EN , TSEK , GHOST, SEPRO ve ISO 9001 Sistem kalite belgeleri ile hem üretim ve yönetim sistemlerinin hem de ürettiği ürünlerin kalitesini güvence altında tutmaktadır. Toplam kalite yönetimi, stratejik yönetim ve değişim yönetimi tekniklerini aktif olarak uygulayarak günün koşullarına uygun ürün ve hizmetler geliştirmektedir. Üretim teknolojileri alanında çağın ve sektörün gelişmelerini takip ederek en üst teknoloji ile üretim yapmak amacıyla üretim teknolojileri alanında ciddi yatırımlara imza atan Kayalar Grup bunun bir neticesi olarak KAS markasını sektörün en kaliteli ve güvenilir markalarından biri haline getirmiştir. KAS Ar-Ge departmanının, üretilmekte olan ürünlere getirdiği inovatif yaklaşımı ve sahip olunan birçok patentli buluş ile KAS ürünleri sektörde kalitesi, güvenilirliği, ergonomisi ve kullanım kolaylığı ile rakiplerinden fark edilen ürünler olarak görülmektedir.



Katılımcı yönetim anlayışı ile süreçlerini sürekli iyileştiren, bilimsel yöntemler ile her türlü sorunu çözüme kavuşturan, takım çalışmaları ile etkin ve verimli bir üretim ortamı oluşturan Kayalar Grup değişimi izlemeye ve kaliteyi peşinden sürüklemeye devam etmektedir.

Sektörün en beğenilen ürünleri ile her türlü çalışmasını müşteri odaklı gerçekleştirmeyi iş hayatının olmazsa olmaz unsurlarından gören Kayalar Grup pazarlama ve müşteri hizmetleri konusunda da geliştirdiği yaklaşımları ve müşteri anlayışı sayesinde sektörün en beğenilen kuruluşlarından birisi olmuştur. Gerek iletişimin, gerek müşteri beklentileri konusundaki hassasiyetin, gerekse satış ve satış sonrası hizmet ve desteklerin geliştirilmesi konusunda yeni yaklaşımlar ve hizmetler üretmek üzere çalışan uzman ekibi ile pazarlama grubu, sektörde müşterisine en hızlı ve en doğru hizmeti sunmayı amaçlamış, yaptığı eğitim ve bilgilendirme faaliyetleri ile sektörün büyümesine ve gelişmesine önemli destek sağlamıştır. Sadece üretim hayatında değil sosyal hizmet anlayışı ile de Kayalar Grup sektördeki benzeri kuruluşlardan ayrıcalıklı bir yapıya kavuşmuştur. Özellikle genç nesillerin eğitimi ve doğru bilgilendirilmesi amacıyla mesleki eğitimleri veren kurum ve kuruluşlar ile yakın diyalog içerisinde bulunmakta ve desteklemektedir. Bu kapsamda çok sayıda öğrenciye destek vermekte ve özellikle metal endüstrisinde eğitim veren teknik liseler başta olmak üzere kurumlarımıza desteklerini esirgememektedir.

Ülkemizin adını yurt dışında da başarı ile temsil eden Kayalar Grup, yurt içinde edindiği tecrübe, kalite yaklaşımı ve müşteri odaklı pazarlama süreçlerinin tüm birikimleri ile ihracat faaliyetlerinde kısa sürede büyük bir ivme yakalamış ve komşu ülkeler başta olmak üzere onlarca ülkeye gerçekleştirdiği ihracatı ile adını ülkemiz sınırları dışına taşımıştır. Gelecek vizyonunda KAS markasını bir dünya markası haline getirmek yatan Kayalar Grup bu bağlamda belirlediği stratejik hedefleri doğrultusunda müşterilerinin de desteği ile yeni ürünleri, yeni kalite yaklaşımları ve müşteri hizmetleri ile geleceğin büyüyen gücü olmaya devam etmektedir.

► İÇİNDEKİLER



► Su ve Doğalgaz
Tesisat Ürünleri

08



► Kas Therm
Isı Sistemleri

24



► Flex Grubu

34



► Kastak Grubu

42



► Armatür

48



► Duş Setleri

102



► PPRC Grubu

118

► Armatür ve Duş Setleri

Yasemin
Gold

50



Yasemin

52



Lilyum

54



Arnika

56



Gülbahar

58



Defne Colored

60



Defne

62



Hilal

64



Gülrihal

66



Çanak

70



Kardelen

72



Nilüfer

74



Antoryum

76



Zirkonyum

78



Medikal

81



Berilyum

82



Mutfak

86



Endüstriyel

89



Fotoselli

90



Ankastre

94



Musluk

95



Taharet
Musluğu

97



Yedek Parça

100



Duş Setleri

102



SU VE DOĐALGAZ TESİSAT ÜRÜNLERİ



Tüketici dostu çözümlerimizin en yenisi

Termostatik Radyatör Vanası

*Yaşam alanınızı istediğiniz ısı seviyesinde tutar,
ihtiyaç fazlası ısınma ve tüketimin önüne geçerek*

%30'a varan tasarruf sağlar

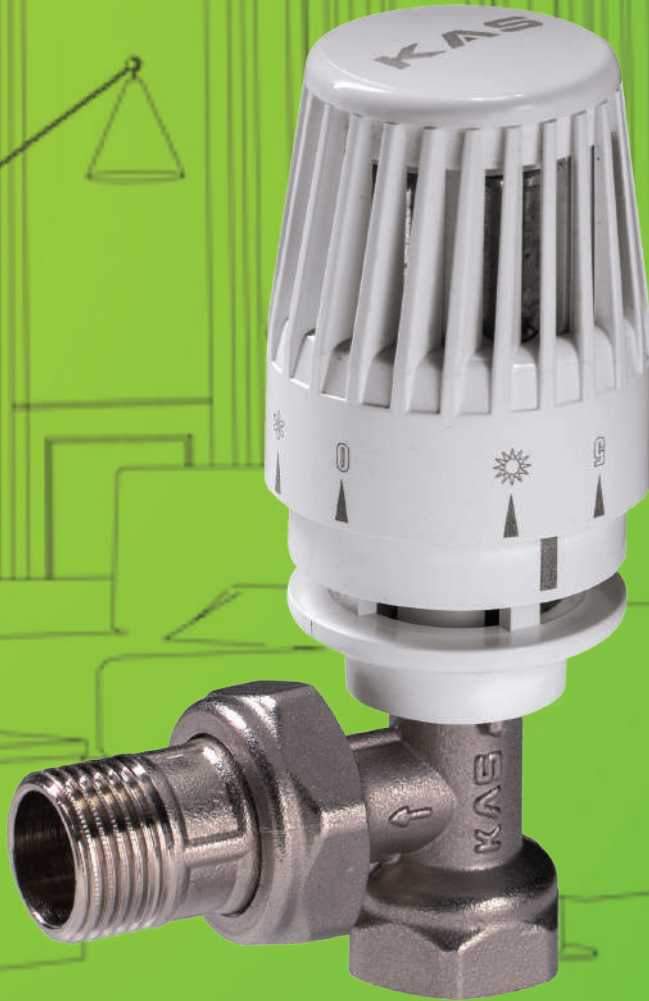

► SU VE DOĞALGAZ TESİSAT ÜRÜNLERİ



TS EN 331
► **Gaz Küresel Vana**
(Mob 5)

KOD	AÇIKLAMA	K. AD.	B. FİYATI
07.04.830	1/2"	100	48,84 TL
07.04.831	3/4"	80	74,40 TL
07.04.402	1"	40	139,00 TL
07.04.403	1 1/4"	20	263,00 TL
07.04.404	1 1/2"	12	401,00 TL
07.04.405	2"	8	602,00 TL



TS EN 331
► **Gaz Küresel Vana - Kilitli**
(Mob 5)

KOD	AÇIKLAMA	K. AD.	B. FİYATI
07.05.830	1/2"	100	52,50 TL
07.05.831	3/4"	80	80,40 TL
07.05.402	1"	40	148,00 TL
07.03.801	3/4"-1/2"	80	96,40 TL



TS EN 13828
► **Su Küresel Vana - İçme Suyu**
(PN 10)

KOD	AÇIKLAMA	K. AD.	B. FİYATI
08.01.430	1/2"	100	69,40 TL
08.01.431	3/4"	80	91,40 TL
08.01.432	1"	40	171,00 TL
08.01.433	1 1/4"	20	277,00 TL
08.01.434	1 1/2"	12	428,00 TL
08.01.435	2"	8	750,00 TL



TS EN 13547
► **Su Küresel Vana - Endüstriyel**
(PN 40)

KOD	AÇIKLAMA	K. AD.	B. FİYATI
08.02.430	1/2"	100	70,50 TL
08.02.431	3/4"	80	95,00 TL
08.02.432	1"	40	164,00 TL
08.02.433	1 1/4"	20	254,00 TL
08.02.434	1 1/2"	12	390,00 TL
08.02.435	2"	8	589,00 TL

► SU VE DOĞALGAZ TESİSAT ÜRÜNLERİ



► **Su Küresel Vana**
(PN 40)

KOD	AÇIKLAMA	K. AD.	B. FİYATI
08.09.530	1/2"	100	51,60 TL
08.09.531	3/4"	80	82,60 TL
08.09.452	1"	40	135,00 TL



► **Su Küresel Vana**
(PN 16)

KOD	AÇIKLAMA	K. AD.	B. FİYATI
80.61.426	2 1/2"	4	2.398,00 TL
80.61.427	3"	3	3.516,00 TL
80.61.428	4"	2	6.718,00 TL



► **Su Küresel Vana**
(PN 40)



KOD	AÇIKLAMA	K. AD.	B. FİYATI
08.09.528	1/4"	120	54,80 TL
08.09.529	3/8"	120	52,20 TL



► **TS EN 13547**
Su Küresel Vana - Endüstriyel
(PN 25)

KOD	AÇIKLAMA	K. AD.	B. FİYATI
08.09.430	1/2"	100	68,30 TL
08.09.431	3/4"	80	88,40 TL
08.09.432	1"	40	159,00 TL
08.09.433	1 1/4"	20	240,00 TL
08.09.434	1 1/2"	12	385,00 TL
08.09.435	2"	8	594,00 TL

► SU VE DOĞALGAZ TESİSAT ÜRÜNLERİ



► **Su Küresel Vana - Kelebek Kollu (PN 25)**

KOD	AÇIKLAMA	K. AD.	B. FİYATI
08.03.430	1/2" Dış Dişli	100	71,40 TL
08.03.431	3/4" Dış Dişli	80	98,40 TL
08.03.432	1" Dış Dişli	40	160,00 TL
08.04.430	1/2" İç Dişli	100	70,80 TL
08.04.431	3/4" İç Dişli	80	91,00 TL
08.04.432	1" İç Dişli	40	160,00 TL

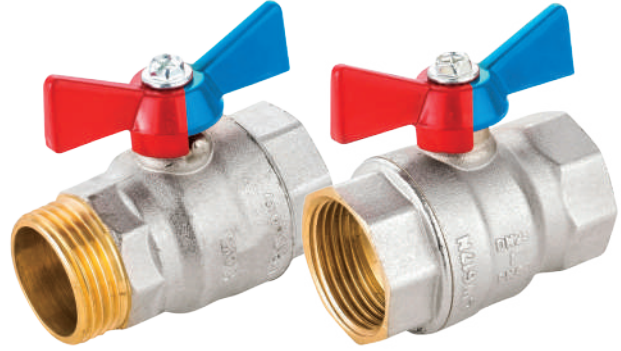

► **Su Küresel Vana - Kelebek Kollu (PN 40)**



KOD	AÇIKLAMA	K. AD.	B. FİYATI
08.03.530	1/2" Dış Dişli	100	54,50 TL
08.03.531	3/4" Dış Dişli	80	79,80 TL
08.03.532	1" Dış Dişli	40	143,00 TL
08.04.530	1/2" İç Dişli	100	54,30 TL
08.04.531	3/4" İç Dişli	80	81,20 TL
08.04.532	1" İç Dişli	40	142,00 TL



► **Rakorlu Su Küresel Vana Kelebek Kollu**

KOD	AÇIKLAMA	K. AD.	B. FİYATI
08.05.530	1/2"	60	90,90 TL
08.05.531	3/4"	50	137,00 TL
08.08.327	1"	40	172,00 TL
08.05.329	1 1/4"	20	306,00 TL



► **Rakorlu Su Küresel Vana Sensör Kovanlı**

KOD	AÇIKLAMA	K. AD.	B. FİYATI
08.09.327	1"	40	191,00 TL

► SU VE DOĞALGAZ TESİSAT ÜRÜNLERİ



► **Dişli - PPRC Bağlantılı Küresel Vana**

KOD	AÇIKLAMA	K. AD.	B. FİYATI
08.08.730	3/4" Dişli - DN20 PPRC Bağlantılı	50	134,00 TL
08.08.731	1" Dişli - DN25 PPRC Bağlantılı	40	181,00 TL
08.08.732	1 1/4" Dişli - DN32 PPRC Bağlantılı	30	251,00 TL



► **PPRC Bağlantılı Küresel Vana**

KOD	AÇIKLAMA	K. AD.	B. FİYATI
08.09.730	DN20 - DN20 PPRC Bağlantılı	50	109,00 TL
08.09.731	DN25 - DN25 PPRC Bağlantılı	40	155,00 TL
08.09.732	DN32 - DN32 PPRC Bağlantılı	30	225,00 TL

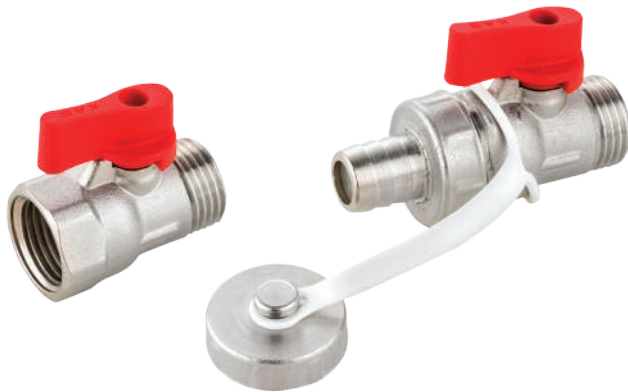

► **Mini Küresel Vana**

KOD	AÇIKLAMA	K. AD.	B. FİYATI
05.03.320	1/4"	250	40,68 TL
05.03.321	3/8"	250	37,96 TL
05.03.322	1/2"	200	44,64 TL
05.03.323	3/4"	120	67,20 TL
05.04.322	1/2" Boşaltma Vanası	200	84,70 TL



► **Filtreli Küresel Vana**

KOD	AÇIKLAMA	K. AD.	B. FİYATI
08.08.448	1/2"	60	129,00 TL
08.08.449	3/4"	50	179,00 TL

► SU VE DOĞALGAZ TESİSAT ÜRÜNLERİ



► Köşe Termostatik Radyatör Vanası (Jaklı)

KOD	AÇIKLAMA	K. AD.	B. FİYATI
13.50.001	1/2"	30	158,00 TL

* 15°C Sabitleme yapılabilir.



► Köşe Termostatik Radyatör Vanası (Jaklı)

KOD	AÇIKLAMA	K. AD.	B. FİYATI
13.50.002	1/2" - 16x2 Pex-B Bağlantılı	30	171,00 TL

* 15°C Sabitleme yapılabilir.



021



023



024



025



► Kompakt Ventil Termostatik Vana

yeni ürün

KOD	AÇIKLAMA	K. AD.	B. FİYATI
23.60.051	Kompakt Ventil	30	173,00 TL
23.60.053	Kompakt Ventil (Alüminyum Radyatör İçin)	30	219,00 TL
23.60.054	Kompakt Ventil	30	196,00 TL
23.60.055	Kompakt Ventil	30	200,00 TL

* 15°C Sabitleme yapılabilir. Termostatik kafa fiyata dahildir.

► Düz Termostatik Vana

KOD	AÇIKLAMA	K. AD.	B. FİYATI
13.40.009	1/2"	30	231,00 TL

* 15°C Sabitleme yapılabilir.

► SU VE DOĞALGAZ TESİSAT ÜRÜNLERİ



► Aksenal Termostatik Vana

KOD	AÇIKLAMA	K. AD.	B. FİYATI
13.40.007	1/2"	30	250,00 TL

* 15°C Sabitleme yapılabilir.

► Aksenal Termostatik Vana

KOD	AÇIKLAMA	K. AD.	B. FİYATI
13.40.008	1/2" Boru Bağlantılı	30	258,00 TL
13.40.006	1/2" Pex Bağlantılı	30	263,00 TL

* 15°C Sabitleme yapılabilir.



► Köşe Radyatör Vanası (Tip3)

KOD	AÇIKLAMA	K. AD.	B. FİYATI
04.07.303	1/2"	50	105,00 TL
04.07.308	1/2" - 16x2 Pex-B Bağlantılı	50	112,00 TL



► Köşe Radyatör Vanası (Tip3)

KOD	AÇIKLAMA	K. AD.	B. FİYATI
04.11.303	1/2"	50	121,00 TL
04.11.308	1/2" - 16x2 Pex-B Bağlantılı	50	128,00 TL

► SU VE DOĞALGAZ TESİSAT ÜRÜNLERİ



► Köşe Rakorlu Vana (Tip6)

KOD	AÇIKLAMA	K. AD.	B. FİYATI
04.14.307-01	1/2"	50	56,30 TL
04.14.309-01	1/2"- 16x2 Pex-B Bağlantılı	50	72,40 TL

(*) Yapı malzemelerinin tabi olacağı kriterler hakkında yönetmelik kapsamındaki yapılarda kullanılmaz.



► Köşe Radyatör Vanası (Tip4)

KOD	AÇIKLAMA	K. AD.	B. FİYATI
04.01.307	1/2"	50	72,70 TL
04.01.309	1/2"- 16x2 Pex-B Bağlantılı	50	82,30 TL



► Köşe Rakorlu Vana

Yeni
ürün

KOD	AÇIKLAMA	K. AD.	B. FİYATI
04.14.307	1/2"	50	52,80 TL
04.14.309	1/2"- 16x2 Pex-B Bağlantılı	50	67,90 TL

(*) Yapı malzemelerinin tabi olacağı kriterler hakkında yönetmelik kapsamındaki yapılarda kullanılmaz.



► Köşe Radyatör Vanası (Tip3)

KOD	AÇIKLAMA	K. AD.	B. FİYATI
04.01.303	1/2"	50	83,20 TL
04.01.308	1/2"- 16x2 Pex-B Bağlantılı	50	94,00 TL
04.05.310	3/4"	50	112,00 TL

► SU VE DOĞALGAZ TESİSAT ÜRÜNLERİ



► **Köşe Radyatör Vanası (Tip3)**

KOD	AÇIKLAMA	K. AD.	B. FİYATI
04.01.304	1/2" - 16x2 Boru Bağlantılı	50	93,90 TL



► **Düz Radyatör Vanası (Tip3)**

KOD	AÇIKLAMA	K. AD.	B. FİYATI
04.02.301	1/2"	50	92,90 TL
04.04.301	1/2" - 16x2 Pex-B Bağlantılı	50	124,00 TL
04.05.311	3/4"	50	130,00 TL



► **Köşe Geri Dönüş Vanası (Tip3)**

KOD	AÇIKLAMA	K. AD.	B. FİYATI
04.04.302	1/2"	100	74,80 TL
04.04.309	1/2" - 16x2 Pex-B Bağlantılı	100	78,60 TL
04.04.305	1/2" G.D. Rakorlu Vana	50	59,60 TL

(*) Yapı malzemelerinin tabi olacağı kriterler hakkında yönetmelik kapsamındaki yapılarda kullanılmaz.



► **Düz - Köşe Rakor**

KOD	AÇIKLAMA	K. AD.	B. FİYATI
03.01.250	1/2" Düz	150	51,00 TL
03.01.251	3/4" Düz	90	74,10 TL
03.01.252	1" Düz	50	113,00 TL
03.02.260	1/2" Köşe	150	62,20 TL
03.02.261	3/4" Köşe	100	92,20 TL
03.02.262	1" Köşe	50	152,00 TL

► SU VE DOĞALGAZ TESİSAT ÜRÜNLERİ



► Filtreli Musluk (PN 10)

KOD	AÇIKLAMA	K. AD.	B. FİYATI
01.07.179	1/2" - 3/8" Taharat Musl.	160	47,77 TL
01.06.173	Çamaşır - Bulaşık Mak. Mus.	100	71,00 TL
01.05.173	Çamaşır - Bulaşık Mak. Mus. (Kumlu)	100	62,90 TL
01.07.179-01	1/2" - 3/8" Taharat Musl. (Aynalı)	160	50,10 TL
01.06.173-01	Çamaşır - Bulaşık Mak. Mus. (Aynalı)	100	72,50 TL
01.05.173-01	Çamaşır - Bulaşık Mak. Mus. (Kumlu) (Aynalı)	100	63,70 TL
01.03.170	Musluk Aynası	600	4,82 TL



► Bahçe Küresel (PN 10) Piriç Rakorlu

KOD	AÇIKLAMA	K. AD.	B. FİYATI
09.06.921	1/2" Tek Parça Rakorlu	50	92,30 TL
09.06.923	1/2" Tek Parça Rakorlu - Yeni	50	77,00 TL
09.03.922	3/4" Rakor 3/4" Bağlantı	50	112,00 TL



► Küresel Bas (PN 10)

KOD	AÇIKLAMA	K. AD.	B. FİYATI
10.01.370	3/4"	50	109,00 TL
10.01.371	3/4" Paslanmaz Kol*	50	135,00 TL
10.01.372	3/4" - 3/4" Bağlantılı	50	115,00 TL

(*) Kol ve somun nemli ortamlarda kullanıma uygun paslanmaz çelikten (AISI 304) imal edilmiştir.

Talep edildiği takdirde kelebek kolu olarak imal edilebilir.



► Bahçe Küresel (PN 10) Piriç Rakorlu Kelebek Kol

KOD	AÇIKLAMA	K. AD.	B. FİYATI
09.07.921	1/2" Tek Parça Rakorlu	50	92,00 TL
09.04.922	3/4" Rakor 3/4" Bağ.	50	112,00 TL

► SU VE DOĞALGAZ TESİSAT ÜRÜNLERİ



► Çalparalı (Yatay) Çekvalf

KOD	AÇIKLAMA	K. AD.	B. FİYATI
80.82.460	1/2"	100	75,90 TL
80.82.461	3/4"	75	96,70 TL
80.82.462	1"	50	141,00 TL
80.82.463	1 1/4"	50	215,00 TL
80.82.464	1 1/2"	40	296,00 TL
80.82.465	2"	15	387,00 TL
80.82.466	2 1/2"	10	744,00 TL
80.82.467	3"	6	928,00 TL



► Yaylı (Dik) Çekvalf - Sessiz

KOD	AÇIKLAMA	K. AD.	B. FİYATI
80.81.470	1/2"	100	62,10 TL
80.81.471	3/4"	75	90,20 TL
80.81.472	1"	50	123,00 TL
80.81.473	1 1/4"	50	199,00 TL
80.81.474	1 1/2"	40	284,00 TL
80.81.475	2"	24	369,00 TL
80.81.476	2 1/2"	12	922,00 TL
80.81.477	3"	6	1.222,00 TL



► Doğalgaz Filtresi - U Manometre

KOD	AÇIKLAMA	K. AD.	B. FİYATI
80.32.820	1/2" Gaz Filtresi	70	189,00 TL
70.02.470	U Manometre	25	406,00 TL
70.03.800	Doğalgaz Tesisat Macunu	24	56,30 TL



► Flatör - Paslanmaz Memeli

KOD	AÇIKLAMA	K. AD.	B. FİYATI
80.71.540	1/2"	50	99,30 TL
80.71.541	3/4"	50	112,00 TL
80.71.542	1"	50	130,00 TL
80.71.543	1 1/4"	20	348,00 TL
80.71.544	1 1/2"	20	402,00 TL
80.71.545	2"	20	446,00 TL

► SU VE DOĞALGAZ TESİSAT ÜRÜNLERİ



► Filtre (Pislik Tutucu)

KOD	AÇIKLAMA	K. AD.	B. FİYATI
12.02.340	1/2" Yeni Tasarım	150	48,39 TL
12.02.341	3/4" Yeni Tasarım	80	69,00 TL
12.02.342	1" Yeni Tasarım	50	115,00 TL
12.01.340	1/2"	150	65,20 TL
12.01.341	3/4"	80	94,90 TL
12.01.342	1"	50	140,00 TL
80.31.343	1 1/4"	30	253,00 TL
80.31.344	1 1/2"	20	305,00 TL
80.31.345	2"	10	461,00 TL
80.31.346	2" 1/2"	8	767,00 TL
80.31.347	3"	6	1.117,00 TL
80.31.348	4"	4	2.364,00 TL



► Uzatma (25 mm)

KOD	AÇIKLAMA	K. AD.	B. FİYATI
80.01.101	1/2" 1 cm	500	13,53 TL
80.01.102	1/2" 1,5 cm	400	17,03 TL
80.01.103	1/2" 2 cm	300	20,50 TL
80.01.104	1/2" 2,5 cm	250	23,41 TL
80.01.105	1/2" 3 cm	200	27,53 TL
80.01.106	1/2" 4 cm	175	33,71 TL
80.01.107	1/2" 5 cm	150	41,39 TL

► Uzatma Grubu

KOD	AÇIKLAMA	K. AD.	B. FİYATI
80.04.160	1/2" - 3/4" Bas Uzatma	250	25,92 TL
80.04.175	3/4" Düz Batarya Uzatması	100	47,27 TL
80.04.176	3/4" Delikli Batarya Uza.	100	51,20 TL
80.04.180	1/2" Bulaşık Makinası Uza.	100	38,45 TL
80.04.185	3/4" Çamaşır Musluk Çatalı	100	57,20 TL



► Şiber Vana

KOD	AÇIKLAMA	K. AD.	B. FİYATI
11.01.850	1/2"	60	100,00 TL
11.01.951	3/4"	50	87,10 TL
11.01.852	1"	30	191,00 TL

► SU VE DOĞALGAZ TESİSAT ÜRÜNLERİ

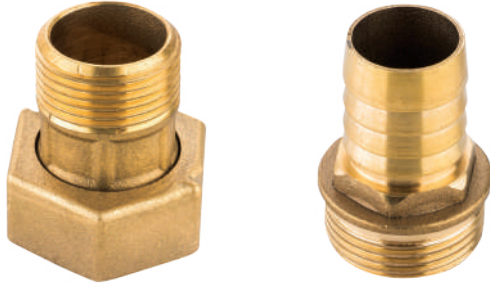

► Rakorlar

KOD	AÇIKLAMA	K. AD.	B. FİYATI
80.23.241	1/2" Hortum Rakoru	500	15,20 TL
80.23.242	3/4" Hortum Rakoru	300	22,96 TL
80.23.243	1" Hortum Rakoru	150	40,12 TL
80.23.244	1 1/4" Hortum Rakoru	100	55,80 TL
80.23.245	1 1/2" Hortum Rakoru	75	79,00 TL
80.23.246	2" Hortum Rakoru	40	147,00 TL
80.22.191	3/4" Su Saati Rakoru	100	42,90 TL



► Stop Vana

KOD	AÇIKLAMA	K. AD.	B. FİYATI
11.02.850	1/2"	60	102,00 TL
11.02.851	3/4"	50	107,00 TL
11.02.852	1"	30	232,00 TL



► Nipel - Kromlu

KOD	AÇIKLAMA	K. AD.	B. FİYATI
02.02.200	3/8"	500	9,72 TL
02.02.201	1/2"	250	18,18 TL
02.02.202	3/4"	200	23,46 TL
02.02.203	1"	100	39,64 TL



► Orantılı Nipel - Redüksiyon

KOD	AÇIKLAMA	K. AD.	B. FİYATI
02.03.210	3/8" - 1/2" Orantılı Nipel	300	15,28 TL
02.03.211	1/2" - 3/4" Orantılı Nipel	250	24,45 TL
02.03.212	3/4" - 1" Orantılı Nipel	100	41,82 TL
02.01.195	3/8" - 1/2" Redüksiyon	500	12,23 TL
02.01.196	1/2" - 3/4" Redüksiyon	300	18,54 TL

► SU VE DOĞALGAZ TESİSAT ÜRÜNLERİ



► Emniyet Ventili - Sabit Ayarlı

KOD	AÇIKLAMA	K. AD.	B. FİYATI
7106610-3	1/2" İç Diş (3 BAR)	20	91,60 TL
7106610-4	1/2" İç Diş (4 BAR)	20	91,60 TL
7106610-5	1/2" İç Diş (5 BAR)	20	91,60 TL
7106610-6	1/2" İç Diş (6 BAR)	20	93,00 TL
7106610-8	1/2" İç Diş (8 BAR)	20	95,10 TL
7106610-9	1/2" İç Diş (9 BAR)	20	104,00 TL
7106610-10	1/2" İç Diş (10 BAR)	20	104,00 TL
7110601-3	1/2" Dış Diş (3 BAR)	20	87,10 TL
7110601-4	1/2" Dış Diş (4 BAR)	20	87,10 TL
7110601-5	1/2" Dış Diş (5 BAR)	20	87,10 TL
7110601-6	1/2" Dış Diş (6 BAR)	20	88,50 TL
7110601-8	1/2" Dış Diş (8 BAR)	20	90,50 TL
7110601-9	1/2" Dış Diş (9 BAR)	20	97,30 TL
7110601-10	1/2" Dış Diş (10 BAR)	20	97,30 TL



Evinizin Her Yerindeyiz!

(Daha fazlası kas.com.tr'de)



► KASTHERM ISI SİSTEMLERİ

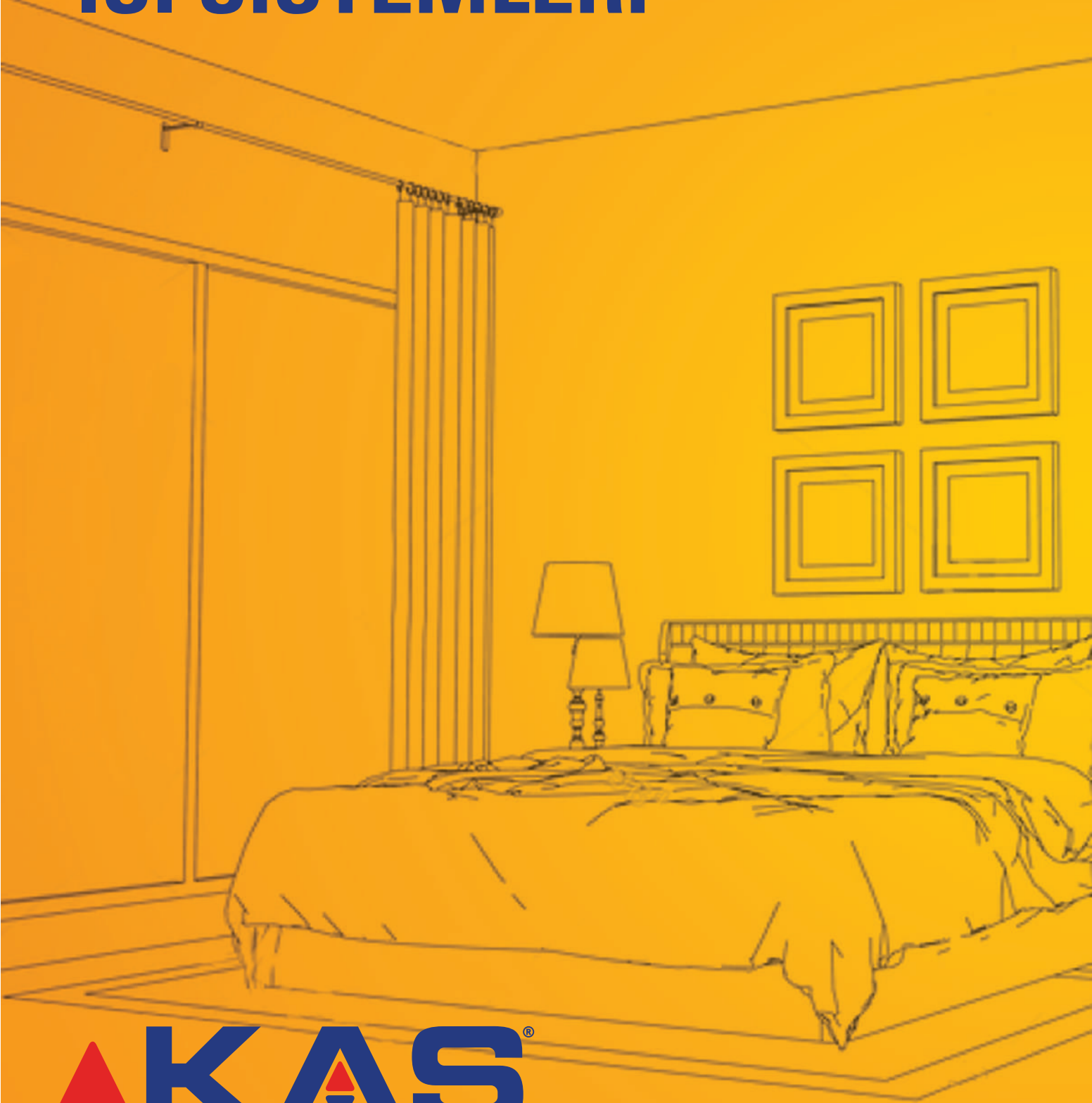

 **KAS**[®]
therm

Yıllara meydan okuyan yeni ürünümüz

Kompakt Karışım Devresi

AR-GE ekibimizin, kaliteden ödün vermeyen inovasyon anlayışı ile tasarladığı, yeni bir teknoloji ile ürettiğimiz, **patentli ürünümüzle** işinizi kolaylaştırmaya devam ediyoruz.

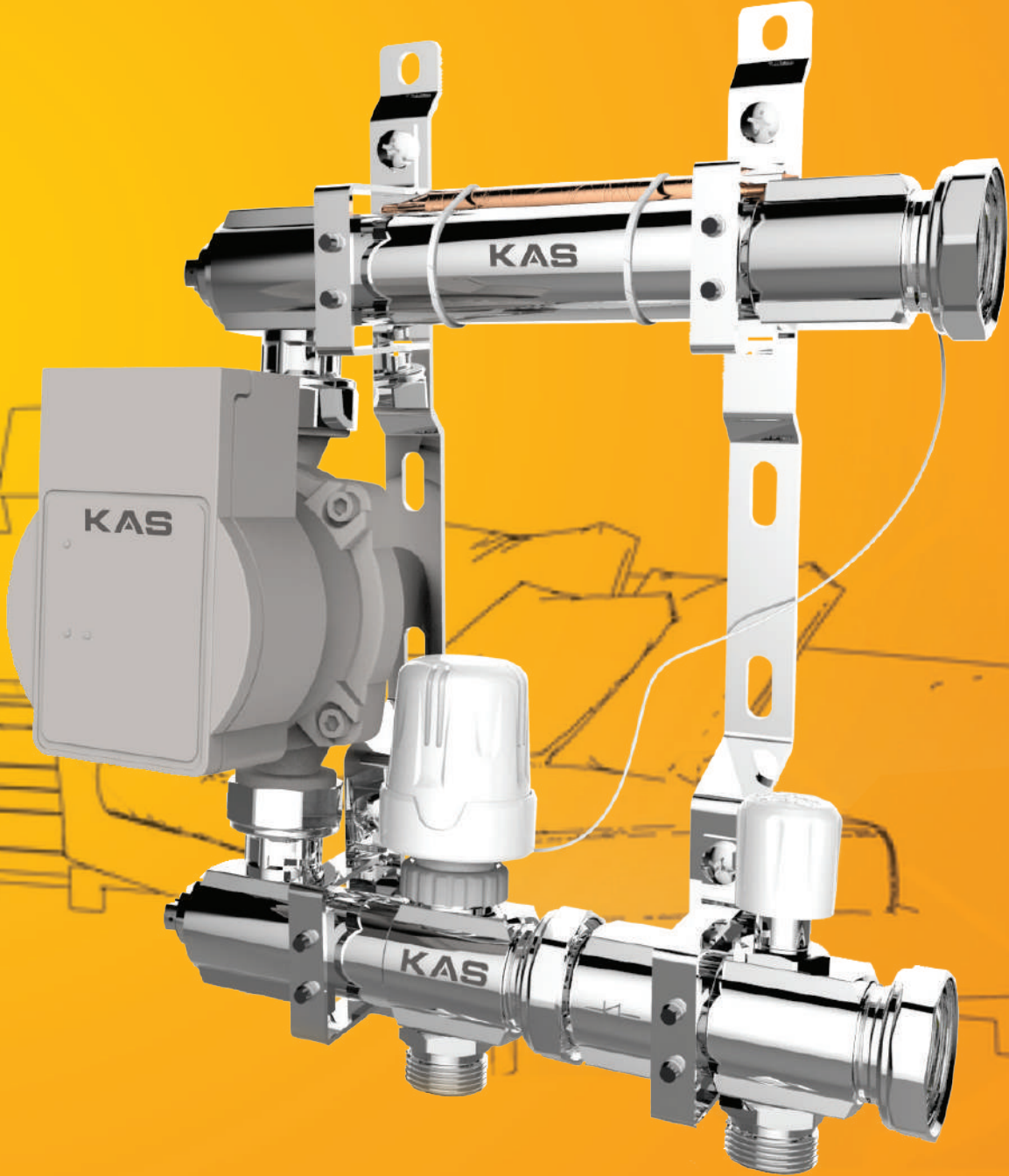

► KASTHERM ISI SİSTEMLERİ

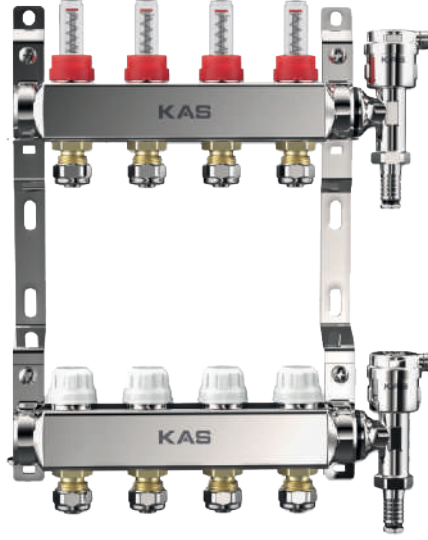

► Kare Tip Set - Debili - Termostat Set

KOD	AÇIKLAMA	K. AD.	B. FİYATI
18.22.902	2 Delikli	1	1.343,00 TL
18.22.903	3 Delikli	1	1.701,00 TL
18.22.904	4 Delikli	1	2.035,00 TL
18.22.905	5 Delikli	1	2.380,00 TL
18.22.906	6 Delikli	1	2.718,00 TL
18.22.907	7 Delikli	1	3.057,00 TL
18.22.908	8 Delikli	1	3.396,00 TL
18.22.909	9 Delikli	1	3.735,00 TL
18.22.910	10 Delikli	1	4.087,00 TL
18.22.911	11 Delikli	1	4.420,00 TL
18.22.912	12 Delikli	1	4.743,00 TL

Kutu İçeriği: 1 Adet Debili Kollektör, 1 Adet Termostatik Salmastralı Kollektör, 2 Adet Tahliye Vanası, 2 Adet Kelepçe

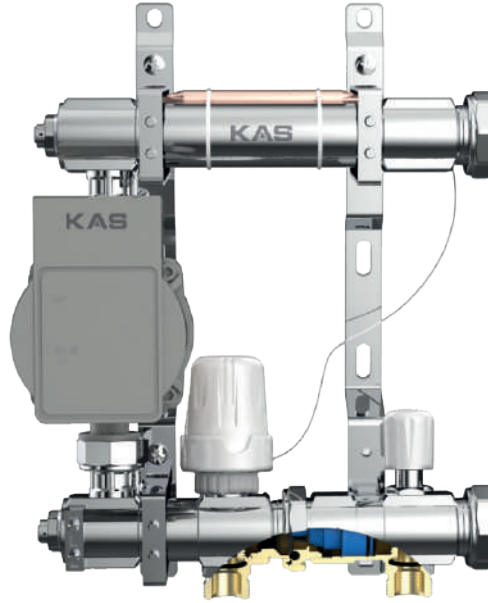

► Kompakt Karışım Devresi

KOD	AÇIKLAMA	K. AD.	B. FİYATI
20.01.001	-	1	2.235,00 TL

Kutu İçeriğine Sirkülasyon pompası dahil değildir.

► KASTHERM ISI SİSTEMLERİ



► Kare Tip Debili Kollektör - Manometre Rakorlu

KOD	AÇIKLAMA	K. AD.	B. FİYATI
18.31.902	2 Delikli	1	378,00 TL
18.31.903	3 Delikli	1	561,00 TL
18.31.904	4 Delikli	1	721,00 TL
18.31.905	5 Delikli	1	893,00 TL
18.31.906	6 Delikli	1	1.062,00 TL
18.31.907	7 Delikli	1	1.230,00 TL
18.31.908	8 Delikli	1	1.400,00 TL
18.31.909	9 Delikli	1	1.538,00 TL
18.31.910	10 Delikli	1	1.742,00 TL
18.31.911	11 Delikli	1	1.910,00 TL
18.31.912	12 Delikli	1	2.072,00 TL

Not: 18.09.345 kodlu plastik purjörli kollektör tapası ayrıca satılır.



► Kare Tip Termostatik Kollektör - Manometre Rakorlu

KOD	AÇIKLAMA	K. AD.	B. FİYATI
18.32.902	2 Delikli	1	334,00 TL
18.32.903	3 Delikli	1	497,00 TL
18.32.904	4 Delikli	1	637,00 TL
18.32.905	5 Delikli	1	787,00 TL
18.32.906	6 Delikli	1	935,00 TL
18.32.907	7 Delikli	1	1.082,00 TL
18.32.908	8 Delikli	1	1.230,00 TL
18.32.909	9 Delikli	1	1.378,00 TL
18.32.910	10 Delikli	1	1.527,00 TL
18.32.911	11 Delikli	1	1.673,00 TL
18.32.912	12 Delikli	1	1.818,00 TL

Not: 18.09.345 kodlu plastik purjörli kollektör tapası ayrıca satılır.

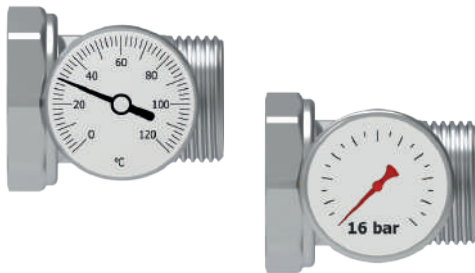

► Kollektör Rakoru - Termometre Saatli

KOD	AÇIKLAMA	K. AD.	B. FİYATI
20.06.005	1" Termometreli	20	170,00 TL
20.06.006	1" Manometreli	20	283,00 TL

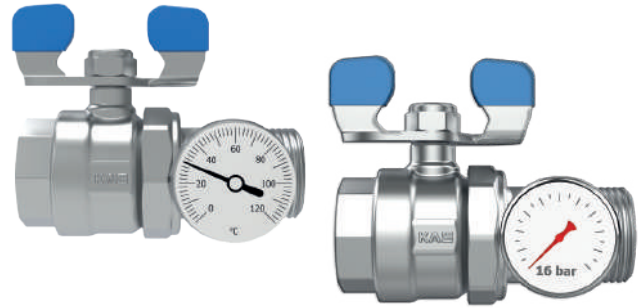

► Rakorlu Su Küresel Vana Sensör Kovanlı

KOD	AÇIKLAMA	K. AD.	B. FİYATI
08.15.327	1" Termometreli	20	298,00 TL
08.16.327	1" Manometreli	20	397,00 TL

► KASTHERM ISI SİSTEMLERİ



► *Çift Taraflı Bağlantı Vanası*

KOD	AÇIKLAMA	K. AD.	B. FİYATI
20.06.001	1"	20	136,00 TL



► *Aktüatör*

KOD	AÇIKLAMA	K. AD.	B. FİYATI
20.07.201	230 V NC, 1 WATT	20	552,00 TL



► *2 Yollu Vana*

KOD	AÇIKLAMA	K. AD.	B. FİYATI
20.06.002	1"	20	237,00 TL

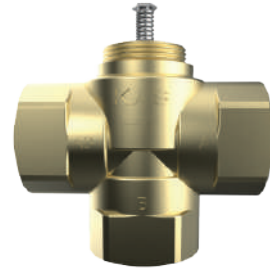

► *3 Yollu Vana*

KOD	AÇIKLAMA	K. AD.	B. FİYATI
20.06.003	1"	20	1.073,00 TL



► *Dijital Oda Termostati*

KOD	AÇIKLAMA	K. AD.	B. FİYATI
20.07.302	230 V / -5°+30° Sıcaklık Aralığı	20	990,00 TL



► *Analog Oda Termostati*

KOD	AÇIKLAMA	K. AD.	B. FİYATI
20.07.301	230 V / -5°+30° Sıcaklık Aralığı	20	548,00 TL

► KASTHERM ISI SİSTEMLERİ

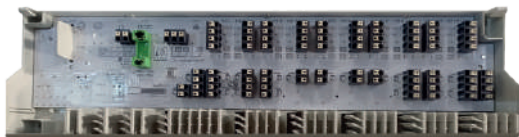

► Dağıtıcı Terminal

KOD	AÇIKLAMA	K. AD.	B. FİYATI
20.07.006	6 Zonlu Maks. 15 Hat	20	1.588,00 TL
20.07.010	10 Zonlu Maks. 18 Hat	20	1.672,00 TL



► Sirkülasyon Pompası

KOD	AÇIKLAMA	K. AD.	B. FİYATI
20.07.101	-	20	5.171,00 TL



► Boru Bağlantı Rakoru ve Sıkma Aparatı

KOD	AÇIKLAMA	K. AD.	B. FİYATI
20.06.004	16x2	20	72,40 TL



► Boru Fittings Sıkma Aparatı

KOD	AÇIKLAMA	K. AD.	B. FİYATI
20.08.001	16-20-25-32 Çene	20	5.864,00 TL



► Termostatik Salmastralı Kollektör 1" 16x2 (PN 10)

KOD	AÇIKLAMA	K. AD.	B. FİYATI
18.16.502	2 Delikli	30	432,00 TL
18.16.503	3 Delikli	20	631,00 TL
18.16.504	4 Delikli	20	826,00 TL
18.16.505	5 Delikli	20	1.024,00 TL
18.16.506	6 Delikli	10	1.245,00 TL
18.16.507	7 Delikli	10	1.446,00 TL
18.16.508	8 Delikli	10	1.648,00 TL
18.16.509	9 Delikli	10	1.848,00 TL
18.16.510	10 Delikli	10	2.051,00 TL
18.16.511	11 Delikli	5	2.255,00 TL
18.16.512	12 Delikli	10	2.464,00 TL
18.16.513	13 Delikli	5	2.673,00 TL

** 17x2 Bağlantı İçin Fiyat Sorunuz



► Debili Kontrollü Kollektör 1" 16x2 (PN 10)

KOD	AÇIKLAMA	K. AD.	B. FİYATI
18.15.502	2 Delikli	20	480,00 TL
18.15.503	3 Delikli	10	703,00 TL
18.15.504	4 Delikli	10	921,00 TL
18.15.505	5 Delikli	10	1.143,00 TL
18.15.506	6 Delikli	5	1.364,00 TL
18.15.507	7 Delikli	5	1.584,00 TL
18.15.508	8 Delikli	5	1.805,00 TL
18.15.509	9 Delikli	5	2.025,00 TL
18.15.510	10 Delikli	5	2.248,00 TL
18.15.511	11 Delikli	5	2.472,00 TL
18.15.512	12 Delikli	5	2.700,00 TL
18.15.513	13 Delikli	5	2.928,00 TL

** 17x2 Bağlantı İçin Fiyat Sorunuz

► KASTHERM ISI SİSTEMLERİ

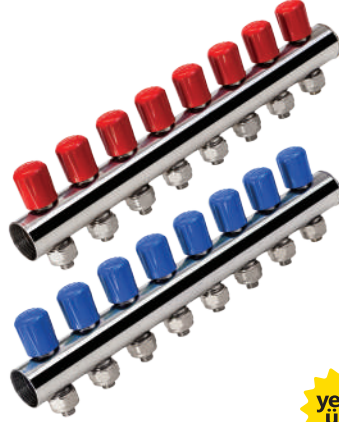

yeni
ürün

► Vanalı Kollektör - Paslanmaz Çelik 1"-16x2 (PN 10)

KOD	AÇIKLAMA	K. AD.	B. FİYATI
18.21.782	2 Delikli	30	181,00 TL
18.21.783	3 Delikli	20	245,00 TL
18.21.784	4 Delikli	20	308,00 TL
18.21.785	5 Delikli	20	377,00 TL
18.21.786	6 Delikli	10	443,00 TL
18.21.787	7 Delikli	10	506,00 TL
18.21.788	8 Delikli	10	571,00 TL
18.21.789	9 Delikli	10	635,00 TL
18.21.790	10 Delikli	10	700,00 TL
18.21.791	11 Delikli	10	785,00 TL
18.21.792	12 Delikli	10	848,00 TL
18.21.793	13 Delikli	10	917,00 TL

** 17x2 Bağlantı İçin Fiyat Sorunuz

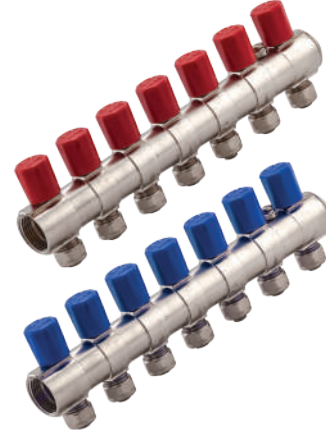

► Vanalı Kollektör - Pirinç 1"-16x2 (PN 10)

KOD	AÇIKLAMA	K. AD.	B. FİYATI
18.01.582	2 Delikli	30	208,00 TL
18.01.583	3 Delikli	20	295,00 TL
18.01.584	4 Delikli	20	380,00 TL
18.01.585	5 Delikli	20	470,00 TL
18.01.586	6 Delikli	10	557,00 TL
18.01.587	7 Delikli	10	641,00 TL
18.01.588	8 Delikli	10	735,00 TL
18.01.589	9 Delikli	10	821,00 TL
18.01.590	10 Delikli	10	913,00 TL
18.01.591	11 Delikli	10	1.007,00 TL
18.01.592	12 Delikli	10	1.110,00 TL
18.01.593	13 Delikli	10	1.192,00 TL

** 17x2 Bağlantı İçin Fiyat Sorunuz



► 3/8 Mini Vanalı Kollektör - Pirinç 1"-16x2 (PN 10)

KOD	AÇIKLAMA	K. AD.	B. FİYATI
18.19.882	2 Delikli	16	248,00 TL
18.19.883	3 Delikli	16	354,00 TL
18.19.884	4 Delikli	16	461,00 TL
18.19.885	5 Delikli	8	569,00 TL
18.19.886	6 Delikli	8	675,00 TL
18.19.887	7 Delikli	8	778,00 TL
18.19.888	8 Delikli	8	893,00 TL
18.19.889	9 Delikli	8	978,00 TL
18.19.890	10 Delikli	8	1.082,00 TL
18.19.891	11 Delikli	8	1.194,00 TL
18.19.892	12 Delikli	8	1.301,00 TL
18.19.893	13 Delikli	8	1.410,00 TL

** 17x2 Bağlantı İçin Fiyat Sorunuz

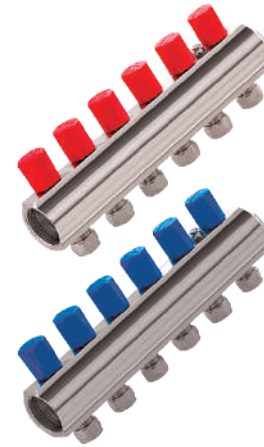

► Vanalı Kollektör - Pirinç 1 1/4"-16x2 (PN 10)

KOD	AÇIKLAMA	K. AD.	B. FİYATI
18.03.703	3 Delikli	16	500,00 TL
18.03.704	4 Delikli	16	646,00 TL
18.03.705	5 Delikli	16	793,00 TL
18.03.706	6 Delikli	8	950,00 TL
18.03.707	7 Delikli	8	1.084,00 TL
18.03.708	8 Delikli	8	1.232,00 TL
18.03.709	9 Delikli	8	1.375,00 TL
18.03.710	10 Delikli	8	1.535,00 TL
18.03.711	11 Delikli	8	1.686,00 TL
18.03.712	12 Delikli	8	1.832,00 TL
18.03.713	13 Delikli	8	1.977,00 TL

** 17x2 Bağlantı İçin Fiyat Sorunuz

► KASTHERM ISI SİSTEMLERİ



► Tahliye Musluğu - Purjör - Kollektör Tapası

KOD	AÇIKLAMA	K. AD.	B. FİYATI
18.09.350	Manuel Purjörlü Tahliye Mus.	75	123,00 TL
18.09.351	Otomatik Purjörlü Tahliye Mus.	75	175,00 TL
80.57.507	1/2" Otomatik Purjör	76	83,20 TL
80.51.550	Test Nipeli	1000	7,13 TL
18.09.345	1" Purjörlü Kollektör Tapası	-	24,45 TL



► H-Ventil / By - Pass Bağlantı

KOD	AÇIKLAMA	K. AD.	B. FİYATI
14.01.878	16 x 2 Deliksiz	40	152,00 TL
06.05.881	H - Ventil	40	324,00 TL

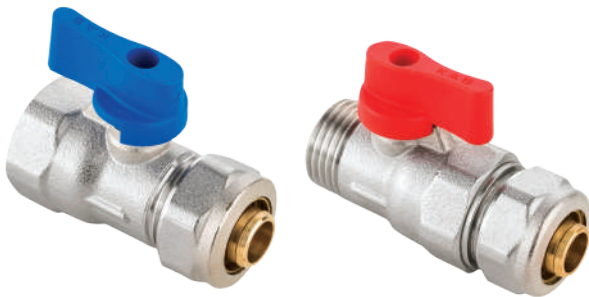

► Yerden Isıtma Mini Küresel Vana

KOD	AÇIKLAMA	K. AD.	B. FİYATI
05.01.312	16 x 2 - 1/2" İç Dişli	180	61,60 TL
05.01.313	17 x 2 - 1/2" İç Dişli	150	95,00 TL
05.02.311	16 x 2 - 3/8" Dış Dişli	150	52,50 TL
05.02.312	16 x 2 - 1/2" Dış Dişli	150	74,90 TL
05.02.313	17 x 2 - 1/2" Dış Dişli	150	110,00 TL

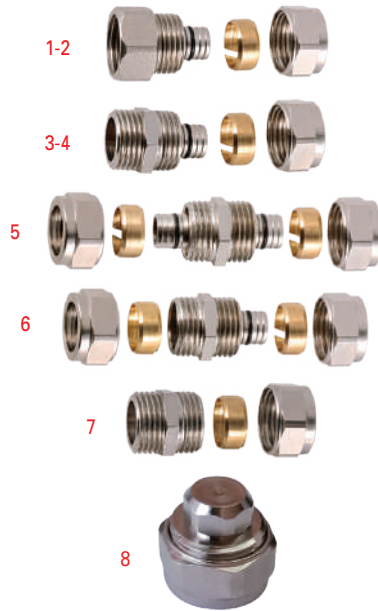

► Yerden Isıtma Bağlantı Rakorları

KOD	AÇIKLAMA	K. AD.	B. FİYATI	
1	06.02.315	16 x 2 İç Dişli	250	32,20 TL
2	06.02.316	17 x 2 İç Dişli	250	45,98 TL
3	06.01.317	17 x 2 Dış Dişli	250	43,32 TL
4	06.01.318	16 x 2 Dış Dişli	250	28,48 TL
5	06.03.319	16 x 2 Hortum - Hortum	250	45,72 TL
6	06.03.320	16 x 2 Hortum - Boru	250	42,62 TL
7	06.01.314	16 x 2 Boru Bağ. Rakoru Dış Dişli	250	25,52 TL
8	06.04.480	16 x 2 Hortum Kör Tapa	250	21,84 TL

► KASTHERM ISI SİSTEMLERİ



► Kollektör Bağlantı Grubu

KOD	AÇIKLAMA	K. AD.	B. FİYATI
70.01.390	40'lık Kollektör Dolabı	1	570,00 TL
70.01.391	60'lık Kollektör Dolabı	1	734,00 TL
70.01.392	80'lık Kollektör Dolabı	1	877,00 TL
18.20.502	1" Kollektör Kelepçesi	40	32,28 TL
18.20.503	1 1/4" Kollektör Kelepçesi	30	36,65 TL
18.20.504	1" Kollektör Kelepçesi	40	34,19 TL



► Şap Katkısı

KOD	AÇIKLAMA	K. AD.	B. FİYATI
20.08.002	-	20	1.422,00 TL

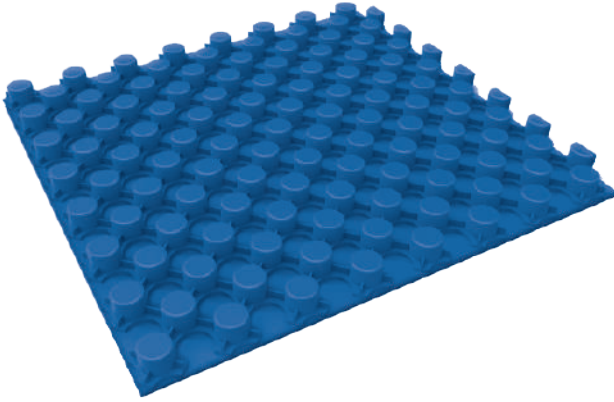

► Yerden Isıtma İzolasyon Paneli

KOD	AÇIKLAMA	K. AD.	B. FİYATI
20.08.010	72 x 72cm	10	-

1 paket= 5.1m²



► Pe-Rt Boru

KOD	AÇIKLAMA	K. AD.	B. FİYATI
80.20.016	16 x 2	200	9,476 TL
80.10.016	16x2 Oksijen Bariyerli	160	11,030 TL

► KASTHERM ISI SİSTEMLERİ



► Radyatör Bağlantı Borusu (Pirinç)

KOD	AÇIKLAMA	K. AD.	B. FİYATI
40.00.040	40 cm	100	56,90 TL
40.00.050	50 cm	100	68,00 TL
40.00.060	60 cm	100	79,30 TL
40.00.090	90 cm	100	121,00 TL



► Radyatör Bağlantı Borusu S'li - Rakorlu

KOD	AÇIKLAMA	K. AD.	B. FİYATI
40.04.040	1/2" - 16x2 Pex-B Bağlantı 40 cm	50	55,70 TL
40.04.050	1/2" - 16x2 Pex-B Bağlantı 50 cm	50	57,00 TL
40.04.060	1/2" - 16x2 Pex-B Bağlantı 60 cm	50	57,90 TL
40.04.090	1/2" - 16x2 Pex-B Bağlantı 90 cm	50	76,30 TL



► Radyatör Bağlantı Borusu Düz - Rakorlu

KOD	AÇIKLAMA	K. AD.	B. FİYATI
40.02.040	1/2" - 16x2 Pex-B Bağlantı 40 cm	70	54,10 TL
40.02.050	1/2" - 16x2 Pex-B Bağlantı 50 cm	70	56,00 TL
40.02.060	1/2" - 16x2 Pex-B Bağlantı 60 cm	50	57,50 TL
40.02.090	1/2" - 16x2 Pex-B Bağlantı 90 cm	50	71,20 TL



► Radyatör Bağlantı Borusu Dirsekli - Rakorlu

KOD	AÇIKLAMA	K. AD.	B. FİYATI
40.10.010	1/2"-16x2 Pex-B Bağlantı 10cm -85°	200	41,41 TL
40.11.010	1/2"-16x2 Pex-B Bağlantı 10cm -90°	200	41,41 TL
40.20.040	1/2"-16x2 Pex-B Bağlantı 40cm	50	56,30 TL
40.20.050	1/2"-16x2 Pex-B Bağlantı 50cm	50	58,30 TL
40.20.060	1/2"-16x2 Pex-B Bağlantı 60cm	50	59,20 TL
40.20.090	1/2"-16x2 Pex-B Bağlantı 90cm	50	73,70 TL

FLEX GRUBU



Paslanmaz elik tel rgs ve kaliteli dıř kaplamasıyla

Gaz Tesisatınızın en gvenilir halkası...

TS EN 14800 Avrupa standartlarına gre retilen, ocak, fırın, kombi vb. gaz yakan cihazlarda kullanılan, eęilebilir ve bklebilir yapıya sahip, **gvenilir, abuk ve kolay baęlantı** saęlayan Gaz Baęlantı Flexleri ile zamandan tasarruf saęlayın.



► FLEX GRUPLARI



TS EN 14800

► Örgülü Doğalgaz Bağlantı Flexi

KOD	N	S	DN	U	K. AD.	B. FİYATI
54.01.050	1/2"	1/2"	DN12	50 cm	25	93,60 TL
54.01.075	1/2"	1/2"	DN12	75 cm	25	110,00 TL
54.01.100	1/2"	1/2"	DN12	100 cm	25	124,00 TL
54.01.125	1/2"	1/2"	DN12	125 cm	25	140,00 TL
54.01.150	1/2"	1/2"	DN12	150 cm	20	161,00 TL
54.01.175	1/2"	1/2"	DN12	175 cm	20	177,00 TL
54.01.200	1/2"	1/2"	DN12	200 cm	20	194,00 TL



TS EN 13890

► Gaz Bağlantı Flexleri - Makaronlu Paslanmaz

KOD	N	S	DN	U	K. AD.	B. FİYATI
42.80.040	3/4"	3/4"	DN16	40 cm	50	85,20 TL
42.80.050	3/4"	3/4"	DN16	50 cm	50	91,80 TL
42.80.060	3/4"	3/4"	DN16	60 cm	30	93,90 TL
42.80.090	3/4"	3/4"	DN16	90 cm	30	115,00 TL
42.80.120	3/4"	3/4"	DN16	120 cm	30	132,00 TL



► Gaz Bağlantı Flexleri Makaronlu

KOD	N	S	DN	U	K. AD.	B. FİYATI
42.15.030	3/4"	1/2"	DN16	30 cm	50	69,90 TL
42.15.040	3/4"	1/2"	DN16	40 cm	50	70,30 TL
42.15.050	3/4"	1/2"	DN16	50 cm	50	80,80 TL
42.15.060	3/4"	1/2"	DN16	60 cm	30	87,30 TL
42.15.090	3/4"	1/2"	DN16	90 cm	50	108,00 TL
42.15.120	3/4"	1/2"	DN16	120 cm	30	127,00 TL
42.15.150	3/4"	1/2"	DN16	150 cm	20	149,00 TL



► Gaz Bağlantı Flexleri Makaronlu

KOD	N	S	DN	U	K. AD.	B. FİYATI
41.17.030	1/2"	3/4"	DN12	30 cm	50	69,10 TL
41.17.040	1/2"	3/4"	DN12	40 cm	50	72,90 TL
41.17.050	1/2"	3/4"	DN12	50 cm	50	77,60 TL
41.17.060	1/2"	3/4"	DN12	60 cm	30	82,80 TL
41.17.090	1/2"	3/4"	DN12	90 cm	30	100,00 TL
41.17.120	1/2"	3/4"	DN12	120 cm	30	114,00 TL

► FLEX GRUPLARI



TS EN 13890

► Kompansatör Bağlantı - Makaronlu

KOD	N	B	DN	U	K. AD.	B. FİYATI
48.02.060	1"	1"	DN25	60 cm	25	344,00 TL
48.12.065	1 1/4"	1 1/4"	DN32	65 cm	20	475,00 TL
48.22.075	1 1/2"	1 1/2"	DN40	75 cm	10	842,00 TL
48.32.085	2"	2"	DN50	85 cm	8	1.363,00 TL
47.57.060	1"	1"	DN25	60 cm	25	369,00 TL
47.59.065	1 1/4"	1 1/4"	DN32	65 cm	20	536,00 TL
47.61.075	1 1/2"	1 1/2"	DN40	75 cm	10	785,00 TL
47.63.085	2"	2"	DN50	85 cm	8	1.034,00 TL



TS EN 13890

► Sayaç Bağlantı Flexi - Makaronlu Paslanmaz

KOD	N	S	DN	U	K. AD.	B. FİYATI
50.80.020	1"	1"	DN25	20 cm	30	191,00 TL
50.80.023	1"	1"	DN25	23 cm	30	189,00 TL
50.80.025	1"	1"	DN25	25 cm	25	191,00 TL
50.80.032	1"	1"	DN25	32 cm	50	201,00 TL
49.41.035	1 1/2"	1 1/2"	DN40	35 cm	10	1.082,00 TL
49.51.035	2"	2"	DN50	35 cm	8	1.155,00 TL



TS EN 13890

► Sayaç Bağlantı Flex Seti - Makaronlu Paslanmaz

KOD	AÇIKLAMA	K. AD.	B. FİYATI
50.92.020	1" 20 cm Ön Bağ. DN25 - 13890	20	254,00 TL
50.90.025	1" 25 cm Ön Bağ. DN25 - 13890	20	259,00 TL
50.90.032	1" 32 cm Ön Bağ. DN25 - 13890	20	267,00 TL
50.91.020	1" 20 cm Yan Bağ. DN25 - 13890	20	256,00 TL
50.93.020	1" 20 cm Ön Bağ. DN25 - 13890	20	286,00 TL
50.93.023	1" 23 cm Ön Bağ. DN25 - 13890	20	283,00 TL

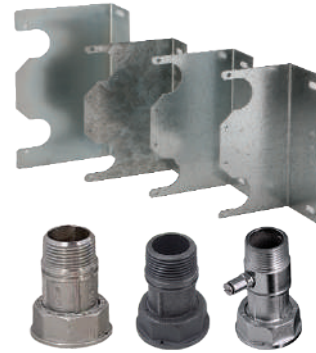

► Sayaç Bağlantı Elemanları

KOD	AÇIKLAMA	K. AD.	B. FİYATI
46.02.440	7.5 cm Konsol Sacı - Ön Bağlantı	50	21,33 TL
46.02.450	8.5 cm Konsol Sacı - Ön Bağlantı	50	20,22 TL
46.02.452	9.5 cm Konsol Sacı - Ön Bağlantı	50	22,66 TL
46.02.453	10.5 cm Konsol Sacı - Ön Bağlantı	50	20,29 TL
46.02.451	Konsol Sacı - Yan Bağlantı	50	21,48 TL
46.20.460	1" Sayaç Rakoru (Döküm)	50	44,00 TL
46.20.461	1" Sayaç Rakoru (Kromlu Döküm)	50	53,27 TL
46.20.463	1" Sayaç Rakoru (Purjörülü)	50	72,40 TL
46.20.470	G 10 - 16 Sayaç Rakoru (Çelik)	50	225,00 TL
46.20.480	G 25 Sayaç Rakoru (Çelik)	25	307,00 TL

► FLEX GRUPLARI



TS EN 13890

► Kaskad Gaz Bağlantı Flexi Paslanmaz

KOD	N	S	DN	U	K. AD.	B. FİYATI
50.70.020	1"	1"	DN25	20 cm	30	185,00 TL
50.70.030	1"	1"	DN25	30 cm	20	191,00 TL
50.70.040	1"	1"	DN25	40 cm	30	209,00 TL
50.70.050	1"	1"	DN25	50 cm	25	220,00 TL
50.70.060	1"	1"	DN25	60 cm	25	234,00 TL



TS EN 13890

► Brülör Bağlantı Flexleri - Makaronlu Paslanmaz

KOD	N	N	DN	U	K. AD.	B. FİYATI
49.03.017	1"	1"	DN25	17 cm	20	164,00 TL
49.12.019	1 1/4"	1 1/4"	DN32	19 cm	15	541,00 TL
49.22.021	1 1/2"	1 1/2"	DN40	21 cm	10	686,00 TL
49.32.021	2"	2"	DN50	21 cm	8	920,00 TL

► Fancoil Flexleri - Çıplak

KOD	N	S	DN	U	K. AD.	B. FİYATI
43.17.020	1/2"	1/2"	DN12	20 cm	50	52,50 TL
43.17.030	1/2"	1/2"	DN12	30 cm	50	53,10 TL
43.17.040	1/2"	1/2"	DN12	40 cm	50	56,40 TL
43.17.050	1/2"	1/2"	DN12	50 cm	50	59,90 TL
43.17.060	1/2"	1/2"	DN12	60 cm	50	63,40 TL

43.19.020	3/4"	3/4"	DN16	20 cm	50	56,60 TL
43.19.030	3/4"	3/4"	DN16	30 cm	50	61,40 TL
43.19.040	3/4"	3/4"	DN16	40 cm	50	66,40 TL
43.19.050	3/4"	3/4"	DN16	50 cm	50	71,20 TL
43.19.060	3/4"	3/4"	DN16	60 cm	30	76,40 TL

43.21.020	1/2"	3/4"	DN12	20 cm	50	53,30 TL
43.21.030	1/2"	3/4"	DN12	30 cm	50	57,80 TL
43.21.040	1/2"	3/4"	DN12	40 cm	50	62,10 TL
43.21.050	1/2"	3/4"	DN12	50 cm	50	64,60 TL
43.21.060	1/2"	3/4"	DN12	60 cm	30	66,30 TL

43.23.020	3/4"	1"	DN16	20 cm	30	94,10 TL
43.23.030	3/4"	1"	DN16	30 cm	30	99,20 TL
43.23.040	3/4"	1"	DN16	40 cm	30	105,00 TL
43.23.050	3/4"	1"	DN16	50 cm	30	109,00 TL
43.23.060	3/4"	1"	DN16	60 cm	25	113,00 TL



► FLEX GRUPLARI



► Fancoil Flexleri - İzoleli

KOD	N	S	DN	U	K. AD.	B. FİYATI
43.18.020	1/2"	1/2"	DN12	20 cm	25	55,50 TL
43.18.030	1/2"	1/2"	DN12	30 cm	25	59,80 TL
43.18.040	1/2"	1/2"	DN12	40 cm	25	64,40 TL
43.18.050	1/2"	1/2"	DN12	50 cm	25	68,90 TL
43.18.060	1/2"	1/2"	DN12	60 cm	25	73,60 TL

43.20.020	3/4"	3/4"	DN16	20 cm	20	62,70 TL
43.20.030	3/4"	3/4"	DN16	30 cm	20	68,70 TL
43.20.040	3/4"	3/4"	DN16	40 cm	20	74,90 TL
43.20.050	3/4"	3/4"	DN16	50 cm	20	81,10 TL
43.20.060	3/4"	3/4"	DN16	60 cm	20	87,60 TL

43.22.020	1/2"	3/4"	DN12	20 cm	25	59,40 TL
43.22.030	1/2"	3/4"	DN12	30 cm	25	62,40 TL
43.22.040	1/2"	3/4"	DN12	40 cm	25	66,90 TL
43.22.050	1/2"	3/4"	DN12	50 cm	25	71,50 TL
43.22.060	1/2"	3/4"	DN12	60 cm	25	75,40 TL

43.24.020	3/4"	1"	DN16	20 cm	25	100,00 TL
43.24.030	3/4"	1"	DN16	30 cm	25	105,00 TL
43.24.040	3/4"	1"	DN16	40 cm	25	113,00 TL
43.24.050	3/4"	1"	DN16	50 cm	25	119,00 TL
43.24.060	3/4"	1"	DN16	60 cm	25	124,00 TL



► Su Bağlantı Flexleri

KOD	N	S	DN	U	K. AD.	B. FİYATI
44.20.010	1/2"	1/2"	DN12	10 cm	100	47,66 TL
44.20.020	1/2"	1/2"	DN12	20 cm	100	48,83 TL
44.20.030	1/2"	1/2"	DN12	30 cm	75	52,40 TL
44.20.040	1/2"	1/2"	DN12	40 cm	75	56,10 TL
44.20.050	1/2"	1/2"	DN12	50 cm	50	56,90 TL
44.20.060	1/2"	1/2"	DN12	60 cm	50	60,40 TL
44.20.090	1/2"	1/2"	DN12	90 cm	50	69,90 TL

► Su Bağlantı Flexleri

KOD	N	S	DN	U	K. AD.	B. FİYATI
44.22.010	1/2"	3/4"	DN12	10 cm	100	76,60 TL
44.22.020	1/2"	3/4"	DN12	20 cm	50	79,60 TL
44.22.030	1/2"	3/4"	DN12	30 cm	50	82,40 TL
44.22.040	1/2"	3/4"	DN12	40 cm	50	85,40 TL
44.22.050	1/2"	3/4"	DN12	50 cm	50	88,50 TL
44.22.060	1/2"	3/4"	DN12	60 cm	50	90,50 TL

45.23.010	3/4"	3/4"	DN16	10 cm	60	67,10 TL
45.23.020	3/4"	3/4"	DN16	20 cm	60	74,20 TL
45.23.030	3/4"	3/4"	DN16	30 cm	50	77,60 TL
45.23.040	3/4"	3/4"	DN16	40 cm	50	81,80 TL
45.23.050	3/4"	3/4"	DN16	50 cm	50	86,00 TL
45.23.060	3/4"	3/4"	DN16	60 cm	30	89,20 TL

► FLEX GRUPLARI KUTU (REGÜLATÖR) BAĞLANTI FLEXLERİ

► Nipel + Nipel Serisi

KOD	AÇIKLAMA	K. AD.	B. FİYATI
47.10.021	1/4" 20 cm (Mak. Paslanmaz N.)	25	255,00 TL
47.12.030-2	1/4" 30 cm (Mak. Paslanmaz N.)	20	359,00 TL

KOD	AÇIKLAMA	K. AD.	B. FİYATI
47.15.020-2	1 1/4" 11/11 Diş 20 cm Mak. Paslanmaz	25	362,00 TL

KOD	AÇIKLAMA	K. AD.	B. FİYATI
47.23.030	1 1/4" 14/11 Diş 30 cm Mak. Paslanmaz	25	463,00 TL

KOD	AÇIKLAMA	K. AD.	B. FİYATI
47.25.034	2" 11/11 Diş 34 cm Mak. Paslanmaz	8	959,00 TL

KOD	AÇIKLAMA	K. AD.	B. FİYATI
47.64.017-2	1/4" 11/11 Diş 16,5 cm Mak. Paslanmaz	25	334,00 TL
47.65.025-2	1/4" 11/11 Diş 25 cm Mak. Paslanmaz	25	353,00 TL

KOD	AÇIKLAMA	K. AD.	B. FİYATI
47.67.025-2	1 1/4" 11/11 Diş 25 cm Mak. Paslanmaz	25	374,00 TL

► Kısa Nipel + Boru Serisi

KOD	AÇIKLAMA	K. AD.	B. FİYATI
47.43.020	1 1/4" 14 Diş 20 cm Mak. Paslanmaz	25	483,00 TL

KOD	AÇIKLAMA	K. AD.	B. FİYATI
47.45.020-2	1 1/4" 11 Diş 20 cm Mak. Paslanmaz	25	482,00 TL

► Nipel + Rakor Serisi

KOD	AÇIKLAMA	K. AD.	B. FİYATI
47.41.020	1 1/4" 11 Diş 20 cm Mak. Paslanmaz	25	533,00 TL

► Nipel + Boru Serisi

KOD	AÇIKLAMA	K. AD.	B. FİYATI
47.37.020	1 1/4" 11 Diş 20 cm Mak. Paslanmaz	25	355,00 TL

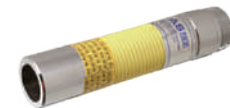

► FLEX GRUPLARI KUTU (REGÜLATÖR) BAĞLANTI FLEXLERİ

► Kısa Nipel + Nipel Serisi

KOD	AÇIKLAMA	K. AD.	B. FİYATI
47.49.017-2	1 1/4" 11/14 Diş 16,5 cm Mak. Paslanmaz	25	337,00 TL

KOD	AÇIKLAMA	K. AD.	B. FİYATI
47.39.025-2	1 1/4" 11 Diş 25 cm Mak. Paslanmaz	20	364,00 TL

► Rakor + Boru Serisi

KOD	AÇIKLAMA	K. AD.	B. FİYATI
47.35.020	1 1/4" 11 Diş 20 cm Mak. Paslanmaz	20	540,00 TL

KOD	AÇIKLAMA	K. AD.	B. FİYATI
47.51.027-2	1 1/4" 11/11 Diş 27 cm Mak. Paslanmaz	20	372,00 TL
47.70.027-2	1 1/4" 11/11 Diş 27 cm Mak. Paslanmaz	20	372,00 TL

► Nipel + Manşon Serisi

KOD	AÇIKLAMA	K. AD.	B. FİYATI
47.21.020-2	1 1/4" 11/11 Diş 20 cm (Mak. Paslanmaz)	25	393,00 TL

KOD	AÇIKLAMA	K. AD.	B. FİYATI
47.27.020	1 1/4" 14/11 Diş 20 cm Mak. Paslanmaz	25	396,00 TL

KOD	AÇIKLAMA	K. AD.	B. FİYATI
47.29.020	2" 11/11 Diş 20 cm Mak. Paslanmaz	8	949,00 TL

KOD	AÇIKLAMA	K. AD.	B. FİYATI
47.31.030	2" 11/11 Diş 34 cm Mak. Paslanmaz	8	975,00 TL

KOD	AÇIKLAMA	K. AD.	B. FİYATI
47.68.022	1 1/4" 11/11 Diş 21,5 cm Mak. Paslanmaz	25	429,00 TL
47.69.022	1 1/2" 11/11 Diş 21,5 cm Mak. Paslanmaz	15	591,00 TL
47.04.030	2" 30 cm Kutu Flex Mak. Paslanmaz	8	980,00 TL
47.06.030	2" 30 cm Kutu Flex N-N (Mak.)	8	933,00 TL

► Kör Tapa

KOD	AÇIKLAMA	K. AD.	B. FİYATI
46.08.007	1 1/4" 14 İnce Diş	100	23,27 TL
46.08.008	1 1/4" 11 Kalın Diş	100	17,85 TL

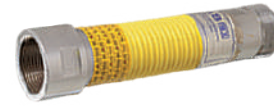
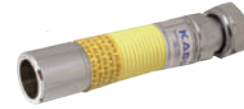

KASTAK GRUBU



Köşeyi döndüren tesisat

Dirsek yok, kaynak yok, avantajı çok!

- Tesisat bölgelerinde kirliliği ve zararı **en aza indirir.**
- Kaynak, pafta, kesme taşı, keten ve macun **gerektirmez.**
- Esnekliği sayesinde dirsek kullanımına **ihtiyaç yoktur.**
- Paslanmaz çelik ve dış kılıfı ile aşınmaya, paslanmaya **dayanıkladır.**
- Kanalların içerisine yerleştirilmesi sayesinde **estetik bir görüntü sağlar.**
- Depreme dayanıklıdır. Japonya ve A.B.D'de 25 yılı aşkın süredir **güvenle kullanılmaktadır.**



Kastak Esnek Tesisat Sistemi



KASTAK®

yeni nesil doğalgaz tesisatı



7



2



6



4



5



10



12



13

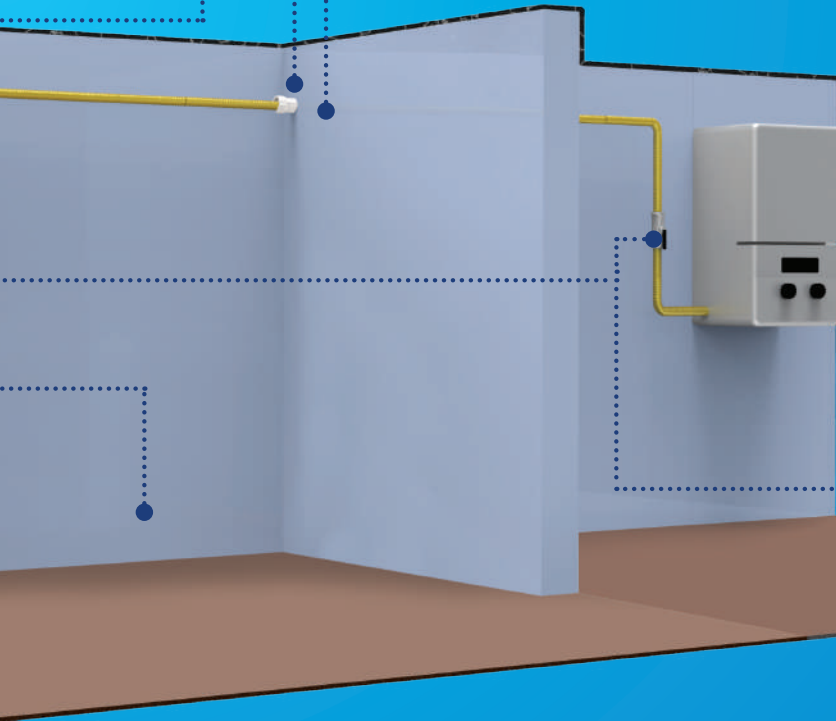

1 L Köşe

2 Dış Köşe

3 İç Köşe

4 Duvar Geçiş Kapağı (Kapalı)

5 Duvar Geçiş Kapağı (Açık)

6 TE Bağlantı Rakorları

7 Hortum Kanalı 3 mt

8 Kanal Geçiş Kapağı

9 Sayaç Kapama

10 Duvar Geçiş Kılıfı

11 Sayaç Bağlantı Rakorları

12 Hortum Bağlantı Rakorları

13 Rakorlu Doğalgaz Vanası

14 Kelepçe

15 Açılı Dış Köşe

► KASTAK GRUBU



► KAS-TAK Daire İçi Tesisat Hortumları

KOD	AÇIKLAMA	K. AD.	B. FİYATI
62.30.016	DN 16 - 45 mt	1	4.600,00 TL
62.30.020	DN 20 - 30 mt	1	3.979,00 TL
62.30.025	DN 25 - 25 mt	1	3.504,00 TL
62.30.050	DN 25 - 50 mt	1	7.135,00 TL
62.33.050	DN 32 - 50 mt	1	9.750,00 TL



yeni ürün

► Rakorlu Doğalgaz Vanası

KOD	AÇIKLAMA	K. AD.	B. FİYATI
66.01.015	DN 25 - 1/2"	20	174,00 TL
66.01.020	DN 25 - 3/4"	20	195,00 TL



► Hortum Bağlantı Rakorları

KOD	AÇIKLAMA	K. AD.	B. FİYATI
60.16.012	DN 16 x 1/2"	30	116,00 TL
60.16.016	DN 16 x 3/4"	24	111,00 TL
60.20.012	DN 20 x 1/2"	40	117,00 TL
60.20.016	DN 20 x 3/4"	40	128,00 TL
60.25.012	DN 25 x 1/2"	24	163,00 TL
60.25.016	DN 25 x 3/4"	32	170,00 TL
60.25.025	DN 25 x 1"	24	169,00 TL
60.32.025	DN 32 x 1"	40	488,00 TL



► TE Bağlantı Rakorları

KOD	AÇIKLAMA	K. AD.	B. FİYATI
61.20.020	DN 25 x DN 20 x DN 20	20	335,00 TL
61.20.021	DN 20 x DN 25 x DN 20	10	330,00 TL
61.20.025	DN 25 x DN 20 x DN 25	20	353,00 TL
61.25.020	DN 25 x DN 25 x DN 20	20	393,00 TL
61.25.025	DN 25 x DN 25 x DN 25	20	452,00 TL
61.32.2525	DN 32 x DN 25 x DN 25	12	738,00 TL
61.32.2532	DN 32 x DN 25 x DN 32	12	966,00 TL
61.32.3225	DN 32 x DN 32 x DN 25	10	957,00 TL
61.32.3232	DN 32 x DN 32 x DN 32	10	1.187,00 TL

► KASTAK GRUBU

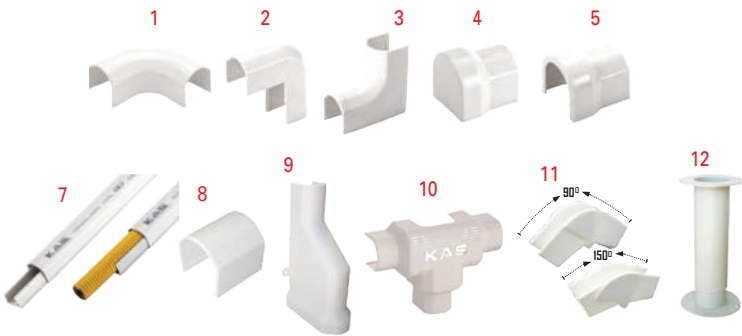

► Hortum Kanalları ve Ek Parçaları - DN 25

KOD	AÇIKLAMA	K. AD.	B. FİYATI
KREM			
1	63.21.003	L Köşe	50 17,42 TL
2	63.21.004	Dış Köşe	50 16,52 TL
3	63.21.005	İç Köşe	50 16,71 TL
4	63.21.006	Duvar Geçiş Kapağı (Kapalı)	50 11,25 TL
5	63.21.007	Duvar Geçiş Kapağı (Açık)	50 12,23 TL
7	63.23.001	Hortum Kanalı 3 mt	9 194,00 TL
8	63.21.010	Kanal Geçiş Kapağı	1 10,50 TL
9	63.21.015	Sayaç Kapama	9 25,37 TL
10	63.21.016	TE Kapama	20 21,35 TL
11	63.21.017	Açılı Dış Köşe	50 22,23 TL
	63.21.018	Açılı İç Köşe	50 22,47 TL
12	-	Duvar Geçiş Kılıfı	1 -

BEYAZ

1	63.22.003	L Köşe	50 17,42 TL
2	63.22.004	Dış Köşe	50 16,52 TL
3	63.22.005	İç Köşe	50 16,71 TL
4	63.22.006	Duvar Geçiş Kapağı (Kapalı)	50 11,25 TL
5	63.22.007	Duvar Geçiş Kapağı (Açık)	50 12,23 TL
7	63.24.001	Hortum Kanalı 3 mt	9 194,00 TL
8	63.22.010	Kanal Geçiş Kapağı	1 10,50 TL
9	63.22.015	Sayaç Kapama	9 25,37 TL
10	63.22.016	TE Kapama	20 21,35 TL
11	63.22.017	Açılı Dış Köşe	50 22,23 TL
	63.22.018	Açılı İç Köşe	50 22,47 TL
12	63.02.014	Duvar Geçiş Kılıfı	1 8,92 TL

► Hortum Kanalları ve Ek Parçaları - DN 32

KOD	AÇIKLAMA	K. AD.	B. FİYATI
63.44.003	L Köşe DN 32	-	21,17 TL
63.44.004	Dış Köşe DN 32	-	21,39 TL
63.44.005	İç Köşe DN 32	-	21,58 TL
63.44.006	Duvar Geçiş Kapağı (Kapalı)	-	21,17 TL
63.44.007	Duvar Geçiş Kapağı (Açık)	-	21,74 TL
63.44.001	Hortum Kanalı 3 mt DN 32	-	243,00 TL
63.44.010	Kanal Geçiş Kapağı	-	20,24 TL



► Sayaç Bağlantı Rakorları (Test Purjölü)

KOD	AÇIKLAMA	K. AD.	B. FİYATI
1	60.25.116	DN 25 - 3/4" Dış Dişli Selenoid Bağlan.	16 228,00 TL
2	60.25.117	DN 25 - 1" Dış Dişli Selenoid Bağlantılı	16 230,00 TL
3	60.25.118	DN 25 - 1" İç Dişli	16 194,00 TL
4	60.25.125	DN 25 - 1 1/4" Döküm Rakorlu	25 310,00 TL
5	60.25.126	DN 25 - 1 1/4" Rakorlu	25 285,00 TL
6	60.32.126	DN 32 - 1 1/4" Test Purjölü	20 817,00 TL

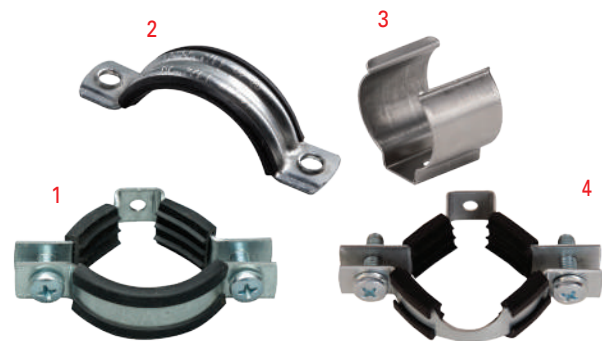

► Bağlantı Kelepçeleri

KOD	AÇIKLAMA	K. AD.	B. FİYATI
1	60.04.011	1/2" Vana Bağlantı	300 11,19 TL
	60.04.012	3/4" Vana Bağlantı	300 10,09 TL
2	60.04.020	DN 20 Te Bağlantı	200 7,93 TL
	60.04.025	DN 25 Te Bağlantı	200 13,10 TL
	60.04.032	DN 32 Te Bağlantı	150 8,82 TL
3	60.05.020	DN 20 Hortum Bağlantı	100 15,88 TL
	60.05.025	DN 25 Hortum Bağlantı	100 18,73 TL
4	60.04.010	DN 25 - 1/2" Vana Bağlantı	100 --
	60.04.013	DN 25 - 3/4" Vana Bağlantı	100 --

▶ ARMATÜR



Kalitede Standartları Aştık!

KAS kalitesinde üretilen banyo, duş, lavabo ve mutfaklarda kullanılan armatürler su ve enerji tasarrufu sağlayarak, ev ekonomisine katkıda bulunuyor



KAS

Evimizin her yerindeyiz!

Yasemin Gold



► Yasemin Gold



► Banyo Bataryası

92.41.911

K. AD.: 10

2.459,00 TL



► Lavabo Bataryası

92.41.912

K. AD.: 6

1.880,00 TL



► Evye Bataryası

92.41.914

K. AD.: 6

2.693,00 TL



KAS

Evimizin her yerindeyiz!

Yasemin



► Yasemin



► Banyo Bataryası

92.41.811

K. AD.: 10

1.311,00 TL



► Lavabo Bataryası

92.41.812

K. AD.: 6

1.076,00 TL



► Evye Bataryası

92.41.814

K. AD.: 6

1.668,00 TL



KAS

Evimizin her yerindeyiz!

Lilyum



► Lilyum



► Banyo Bataryası

92.43.001

K. AD.: 12

941,00 TL



► Lavabo Bataryası

92.43.002

K. AD.: 12

843,00 TL



► Lüks Evye Bataryası

92.43.004

K. AD.: 12

1.256,00 TL



► Evye Bataryası

92.43.005

K. AD.: 12

651,00 TL



KAS

Evimizin her yerindeyiz!

Arnika



► Arnika



► **Banyo Bataryası**
92.42.101
 K. AD.: 12
811,00 TL



► **Lavabo Bataryası**
92.42.102
 K. AD.: 12
657,00 TL



► **Duř Bataryası**
92.42.108
 K. AD.: 12
581,00 TL



► **Aplike Evye Bataryası**
92.42.107
 K. AD.: 12
660,00 TL



► Arnika



► Lavabo Bataryası

K. AD.: 12

► **U** 92.42.117
662,00 TL

► **L** 92.42.119
680,00 TL



► Evye Bataryası

K. AD.: 12

► **U** 92.42.118
672,00 TL

► **L** 92.42.120
690,00 TL

► Gülbahar



► Tek Girişli Lavabo Bataryası

92.55.057

K. AD.: 12

309,00 TL



KAS

Esniğin her yerindeyiz!



Tüm Armatür Ürünlerimiz
320 Farklı Renk
Seçeneđi ile
Zevkinize Göre Sizlerle...

KAS

Evimizin her yerindeyiz!

Defne

colored



► Defne Colored



► **Banyo Bataryası**
92.42.801-B2

K. AD.: 12
000,00 TL



► **Lavabo Bataryası**
92.42.802-B4

K. AD.: 12
000,00 TL



► **Evye Bataryası**
92.42.806-B3

K. AD.: 12
000,00 TL



► **Evye Bataryası**
92.42.807-B1

K. AD.: 12
000,00 TL



KAS

Evimizin her yerindeyiz!

Defne



► Defne



► **Banyo Bataryası**
92.42.801

K. AD.: 12
928,00 TL



► **Lavabo Bataryası**
92.42.802

K. AD.: 12
828,00 TL



► **Evye Bataryası**
92.42.806

K. AD.: 12
1.303,00 TL



► **Lavabo Bataryası**
92.42.809

K. AD.: 12
662,00 TL



► **Evye Bataryası**
92.42.807

K. AD.: 12
672,00 TL



KAS

Evinizin her yerindediriz!

Hilal



► Hilal



► **Banyo Bataryası**
92.31.201

K. AD.: 12
846,00 TL



► **Lavabo Bataryası**
92.31.202

K. AD.: 12
748,00 TL



► **Lavabo Bataryası**
K. AD.: 12

► **U** **92.31.215**
795,00 TL

► **L** **92.31.205**
805,00 TL



► **Evye Bataryası**
K. AD.: 12

► **U** **92.31.216**
805,00 TL

► **L** **92.31.206**
815,00 TL



KAS

Evimizin her yerindeyiz!

Gülnihal



► **Gülnihal**

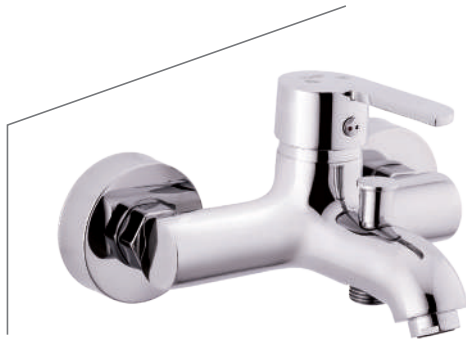

► **Banyo Bataryası**
92.42.201
 K. AD.: 12
759,00 TL



► **Lavabo Bataryası**
92.42.202
 K. AD.: 12
618,00 TL



► **Aplike Evye Bataryası**
92.42.207
 K. AD.: 12
645,00 TL



► **Duş Bataryası**
92.42.208
 K. AD.: 12
560,00 TL



► Gülnihal



► Lavabo Bataryası

K. AD.: 12

► **U** 92.42.215
570,00 TL

► **L** 92.42.220
578,00 TL



► Evye Bataryası

K. AD.: 12

► **U** 92.42.216
580,00 TL

► **L** 92.42.221
589,00 TL



► Gülnihal



► Lavabo Bataryası

K. AD.: 12

► **F** 92.42.203
584,00 TL

► **L** 92.42.205
535,00 TL



► Evye Bataryası

K. AD.: 12

► **F** 92.42.204
596,00 TL

► **L** 92.42.206
545,00 TL



KAS

Evinizin her yerindedir!

Çanak

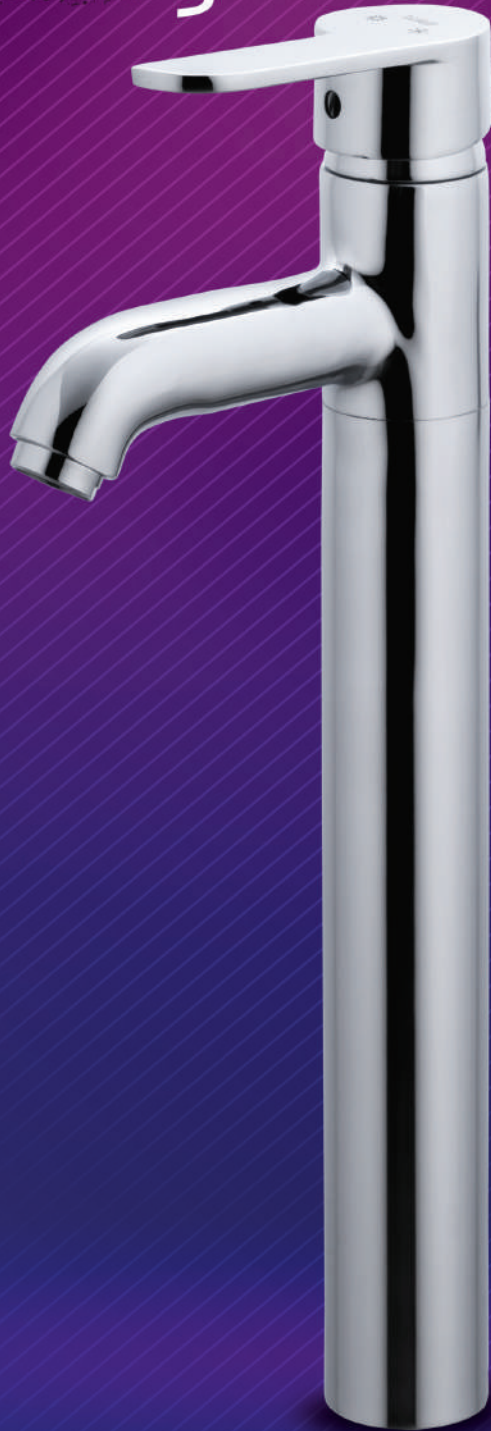

► Çanak



► **Gülnehal Çanak Lavabo**
92.42.217
 K. AD.: 6
1.501,00 TL



► **Gülbade Çanak Lavabo**
92.41.255
 K. AD.: 6
2.822,00 TL



► **Manolya Çanak Lavabo**
92.41.617
 K. AD.: 6
1.769,00 TL



KAS

Evimizin her yerindeyiz!

Kardelen



► Kardelen



► **Banyo Bataryası**
92.31.701
 K. AD.: 12
682,00 TL



► **Lavabo Bataryası**
92.31.702
 K. AD.: 12
601,00 TL



► **Lavabo Bataryası**
92.31.703
 K. AD.: 12
460,00 TL



► **Evye Bataryası**
92.31.704
 K. AD.: 12
468,00 TL



KAS

Evimizin her yerindeyiz!

Nilüfer



► Nilüfer



► **Banyo Bataryası**
92.41.301
 K. AD.: 12
635,00 TL



► **Lavabo Bataryası**
92.41.302
 K. AD.: 12
526,00 TL



► **Lavabo Bataryası**
92.41.303
 K. AD.: 12
436,00 TL



► **Evye Bataryası**
92.41.304
 K. AD.: 12
444,00 TL



KAS

Evimizin her yerindeyiz!

Antoryum



► Antoryum



► **Banyo Bataryası**
92.31.951
 K. AD.: 12
617,00 TL



► **Lavabo Bataryası**
92.31.952
 K. AD.: 12
791,00 TL



► **Lavabo Bataryası**
92.31.953
 K. AD.: 12
432,00 TL



► **Evye Bataryası**
92.31.954
 K. AD.: 12
442,00 TL



► **Aplike Evye Bataryası**
92.31.958
 K. AD.: 12
733,00 TL



KAS

Evimizin her yerindeyiz!

Zirkonyum



► Zirkonyum



► Banyo Bataryası

92.31.901

K. AD.: 12

591,00 TL



► Lavabo Bataryası

92.31.902

K. AD.: 12

499,00 TL



► Lavabo Bataryası

92.31.903

K. AD.: 12

416,00 TL



► Evye Bataryası

92.31.904

K. AD.: 12

426,00 TL



► Aplike Evye Bataryası

92.31.932

K. AD.: 12

717,00 TL



► Zirkonyum



► **Yarı Ankastr
Banyo Bataryası**
92.31.920
K. AD.: 12
878,00 TL



► **Aplike Evye Bataryası**
92.31.907
K. AD.: 12
675,00 TL



► **Duş Bataryası**
92.31.908
K. AD.: 12
599,00 TL



► **Döner Lavabo Bataryası**
92.31.930
K. AD.: 12
500,00 TL



► **Döner Evye Bataryası**
92.31.931
K. AD.: 12
510,00 TL



► Zirkonyum Medikal



► **Aplike Evye Bataryası**
92.31.913
 K. AD.: 12
684,00 TL



► **Lavabo Bataryası**
92.31.912
 K. AD.: 12
522,00 TL



► **Döner Lavabo Bataryası**
92.31.910
 K. AD.: 12
530,00 TL



► **Döner Evye Bataryası**
92.31.911
 K. AD.: 12
540,00 TL

KAS

Evinizin her yerindediziz!

Berilyum



► Berilyum



► Banyo Bataryası

92.42.901

K. AD.: 12

569,00 TL



► Lavabo Bataryası

92.42.902

K. AD.: 12

455,00 TL



► Lavabo Bataryası

92.42.903

K. AD.: 12

402,00 TL



► Evye Bataryası

92.42.904

K. AD.: 12

420,00 TL



► Berilyum



► **Yarı Ankastr**
Banyo Bataryası
92.42.910
K. AD.: 12
884,00 TL



► **Aplike Evye Bataryası**
92.42.907
K. AD.: 12
605,00 TL



► **Duř Bataryası**
92.42.908
K. AD.: 12
527,00 TL



► **Döner Lavabo Bataryası**
92.42.915
K. AD.: 12
486,00 TL



► **Döner Evye Bataryası**
92.42.916
K. AD.: 12
496,00 TL



YENİLENEN GÖVDESİYLE ÇOK DAHA GÜÇLÜ ve UZUN ÖMÜRLÜ



► **AÇIKLIK PAYI**

Duvara montaj sonrası kolun çalışmasına engel olmayacak yeterli açıklık.

► **ÇİFT CONTA**

Çift conta ile kuvvetlendirilmiş sızdırmazlık, uzun ömürlü, yüksek dayanım.

► **TEFLON**

PTFE (Teflon) sızdırmazlık elemanı ile uzun ömür, yüksek dayanım, 1. sınıf sızdırmazlık.

► **PASLANMAZ FİLTRE**

Çift taraflı yataklanmış gerçek paslanmazlık özelliğine sahip 304 kaliteli malzemeden, tıkanma ve bakım zamanını uzatan, uzun ve büyük filtre.

► **PİRİNÇ GÖVDE**

Tamamı avrupa normunda pirinç malzemeden yapılmış gövde ve parçaları.

► **ANAHTAR AĞIZI**

Ürüne zarar vermeden montaj imkanı veren anahtar ağzı.

► **ERGONOMİK TASARIM**

3 barda 35 lt/dk çıkış sağlayan ergonomik tasarım.

► **VİDASIZ TASARIM**

Patentli klik geçme tasarım vida paslanması, vidanın gövdeye kaynaması sorunlarına son.

► **FİLTRE YUVASI**

Su akışına engel olmayan geniş filtre yuvası.

KAS

Evinizin her yerindedir!

Mutfak Ürünleri



► Mutfak Ürünleri



► Evye Bataryası (Ayrıtmalı)

92.42.222

K. AD.: 12

1.711,00 TL



► Evye Bataryası (Ayrıtmalı)

92.42.223

K. AD.: 12

1.729,00 TL



► Gülnihal Evye Bataryası (Ayrıtmalı)

92.42.226

K. AD.: 12

1.429,00 TL



► Spiralli Evye Bataryası

92.31.220

K. AD.: 12

1.704,00 TL



► Mutfak Ürünleri



► **Spiralli Evye Bataryası**
92.52.003

K. AD.: 12
1.866,00 TL



► **Spiralli Evye Bataryası**
92.31.221

K. AD.: 12
1.725,00 TL



► **Akrobat Evye Bataryası**
92.31.041

K. AD.: 12
1.621,00 TL



► **Akrobat Evye Bataryası**
92.31.042

K. AD.: 12
1.633,00 TL



► Endüstriyel Mutfak Ürünleri



► Endüstriyel Çift Çıkışlı Evye Bataryası 92.52.001

K. AD: 12

2.985,00 TL



► Endüstriyel Tek Çıkışlı Evye Bataryası 92.52.002

K. AD: 12

1.992,00 TL



KAS

Evinizin her yerindedir!

Fotoselli



► Fotoselli



► **Sardunya Fotoselli Lavabo Bataryası** **92.51.031 - Çift Çıkışlı**

K. AD: 12
2.891,00 TL

92.51.041 - Tek Çıkışlı

K. AD: 12
2.448,00 TL



► **Petunya Fotoselli Lavabo Bataryası** **92.51.011 - Çift Çıkışlı**

K. AD: 12
2.896,00 TL

92.51.021 - Tek Çıkışlı

K. AD: 12
2.452,00 TL



► **Fulya Fotoselli Lavabo Bataryası** **92.51.051 - Çift Çıkışlı**

K. AD: 12
2.792,00 TL

92.51.061 - Tek Çıkışlı

K. AD: 12
2.348,00 TL



Renk seçenekleri için fiyat sorunuz.



► Fotoselli



► **Antoryum Fotoselli
Lavabo Bataryası**
92.51.069 - Çift Çıkışlı - "U"

K. AD.: 12
2.354,00 TL

92.51.068 - Tek Çıkışlı - "U"

K. AD.: 12
1.896,00 TL



► **Antoryum Fotoselli
Lavabo Bataryası**
92.51.072 - Çift Çıkışlı - "L"

K. AD.: 12
1.884,00 TL

92.51.071 - Tek Çıkışlı - "L"

K. AD.: 12
1.426,00 TL



► **Gülsude Fotoselli Triptonik
Lavabo Bataryası**
92.51.074 - Çift Çıkışlı

K. AD.: 12
2.352,00 TL

92.51.073 - Tek Çıkışlı

K. AD.: 12
1.893,00 TL



► Fotoselli Triptonik



► **Gülnür Fotoselli Triptonik
Lavabo Bataryası**
92.51.065 - Çift Çıkışlı

K. AD.: 12
2.483,00 TL

92.51.064 - Tek Çıkışlı

K. AD.: 12
2.024,00 TL



► **Lilyum Fotoselli Triptonik
Lavabo Bataryası**
92.51.063 - Çift Çıkışlı

K. AD.: 12
2.604,00 TL

92.51.062 - Tek Çıkışlı

K. AD.: 12
2.254,00 TL



► **Gülnür Çanak Fotoselli Triptonik
Lavabo Bataryası**
92.51.067 - Çift Çıkışlı

K. AD.: 12
2.775,00 TL

92.51.066 - Tek Çıkışlı

K. AD.: 12
2.316,00 TL



► Ankastre



► Zaman Ayarlı Pisuvar Musluğu

92.81.005

K. AD.: 8

540,00 TL



► Pisuvar Musluğu

92.81.004

K. AD.: 12

729,00 TL



► Lüks Ankastre

Aç-Kapa Musluk (PPRC)

92.11.330 1/2"

K. AD.: 36

219,00 TL

92.11.331 3/4"

K. AD.: 36

220,00 TL



► Prestij

Aç-Kapa Ankastre (PPRC 1/2")

92.81.002

K. AD.: 50

282,00 TL



► Musluk



► **Kumru Aç - Kapa
Kısa Musluk**
92.11.201
K. AD.: 50
240,00 TL



► **Kumru Aç - Kapa
Uzun Musluk**
92.11.202
K. AD.: 50
242,00 TL



► **Kumru Aç - Kapa
Çamaşır Musluk**
92.11.203
K. AD.: 30
240,00 TL



► **Nehir Aç - Kapa
Kısa Musluk**
92.11.016
K. AD.: 50
118,00 TL



► **Nehir Aç - Kapa
Uzun Musluk**
92.11.017
K. AD.: 50
118,00 TL



► **Nehir Aç - Kapa
Çamaşır Musluk**
92.11.019
K. AD.: 30
118,00 TL

► Kumru Musluk



► **Topaç Kısa Musluk**
92.11.001
K. AD.: 50
132,00 TL



► **Topaç Uzun Musluk**
92.11.002
K. AD.: 50
132,00 TL



► **Topaç Çamaşır Musluk**
92.11.003
K. AD.: 50
132,00 TL



► **Piramit Uzun Musluk**
92.11.102
K. AD.: 50
135,00 TL



► **Piramit Çamaşır Musluk**
92.11.103
K. AD.: 50
135,00 TL



► **Piramit Kısa Musluk**
92.11.101
K. AD.: 50
134,00 TL

► Taharet Musluğu (Aç-Kapa)



► **Deniz**
92.11.365 3/8"
K. AD.: 50
115,00 TL



► **Nehir**
92.11.366 3/8"
K. AD.: 50
115,00 TL



► **Irmak**
92.11.367 3/8"
K. AD.: 50
115,00 TL



► **Damla**
92.11.368 3/8"
K. AD.: 50
76,70 TL



► **Yağmur**
92.11.332 3/8"
K. AD.: 50
204,00 TL



► **Yaprak**
92.11.347 3/8"
K. AD.: 50
91,50 TL



► Taharet Musluğu (Aç-Kapa)



► **Billur**
92.11.369 3/8"
K. AD.: 50
100,00 TL



► **Pınar**
92.11.370 3/8"
K. AD.: 50
82,00 TL



► **Sude**
92.11.373 3/8"
K. AD.: 50
64,90 TL



► **Çisil**
92.11.374 3/8"
K. AD.: 50
85,30 TL



► **Derya**
92.11.371 3/8"
K. AD.: 50
82,10 TL



► **Papatya**
92.11.375 3/8"
K. AD.: 50
67,60 TL

KAS®

Evimizin her yerindeyiz!

Yeni Nesil Aç-Kapa Taharet

Özenli, özverili teknik çalışmalar ve ince detaylarla **KAS** aç-kapa taharet ürünü düşük çevirme sayesinde ergonomi ve tasarruf sağlar.

Özel Conta Kullanımı

KAS Sistem

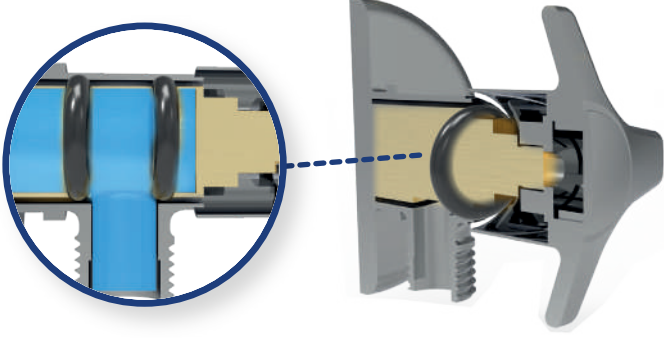

Yeni geliştirdiğimiz sistemde özel üretilen conta sayesinde tesisattan gelen pisliğin meydana getirdiği zarar %90 oranında ortadan kalkmaktadır.

Diğer Ürünler

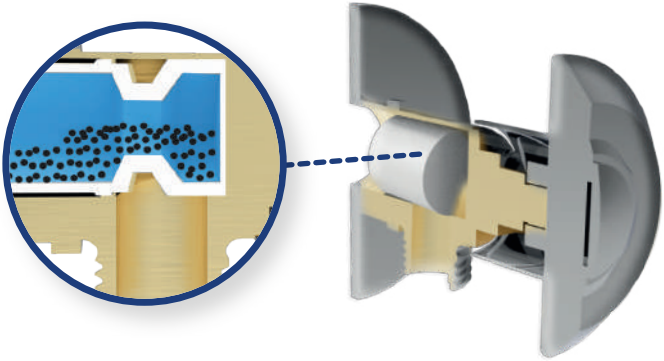

Tesisata doğru gelen pislik piyasa ürünlerinde kullanılan seramiği çizici nedeniyle çok kısa sürede sızdırmaya ve tesisatın bozulmasına sebep olmaktadır.

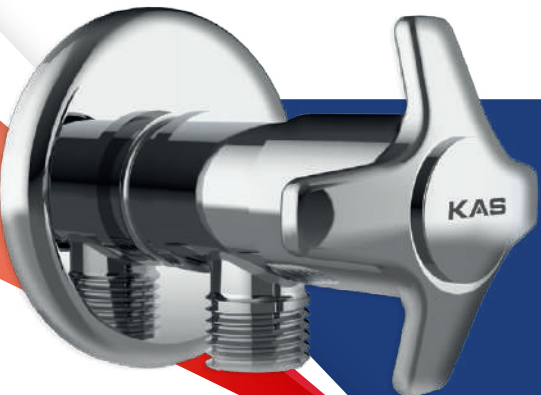

200° Kontrol Aralığı

KAS Sistem



Aç - Kapa ürünümüz 200° kullanım aralığı sağladığı için daha kontrollü ve konforlu su akışı sağlamaktadır. Bu özelliğiyle etrafa su sıçrama problemini ortadan kaldırmaktadır.

Diğer Ürünler



Diğer ürünlerde Aç - Kapa kullanım aralığı 70°dir. Düşük kullanım aralığından dolayı kontrolsüz ve konforsuz bir kullanım söz konusudur. Bu nedenle kullanım esnasında etrafa su sıçraması yüksek olasılıktır.

KAS®

Evimizin her yerindeyiz!

**Sistem
Aç - Kapa
Taharete**

%50

**'ye Varan Tasarruf
sağlamaktadır.**

► Yedek Parça



► **Yıldız Volan**
91.10.123
K. AD.: 50
21,09 TL



► **Yıldız Volan ve Salmastra**
91.10.343
K. AD.: 50
49,79 TL



► **Topaç Volan**
91.10.121
K. AD.: 50
26,40 TL



► **Topaç Volan ve Salmastra**
91.10.341
K. AD.: 50
56,80 TL



► **Piramit Volan**
91.10.122
K. AD.: 50
28,44 TL



► **Piramit Volan ve Salmastra**
91.10.342
K. AD.: 50
59,20 TL

► Yedek Parça



► Taharet Salmastrası

92.10.013

K. AD.: 50

30,03 TL



► 35'lik Kısa Kartuş

91.10.232

K. AD.: 50

36,32 TL



► Aç - Kapa Salmastra

91.10.012

K. AD.: 50

65,30 TL



► 35'lik Ayaklı Kartuş

91.10.231

K. AD.: 50

36,01 TL



► Salmastra

91.10.011

K. AD.: 50

39,39 TL



► 40'lik Kısa Kartuş

91.10.233

K. AD.: 50

36,32 TL



► Taharat Volan

91.10.124

K. AD.: 50

13,86 TL



► 40'lik Ayaklı Kartuş

91.10.234

K. AD.: 50

34,99 TL



DUŞ SETLERİ



Modern, estetik ve fonksiyonel duř setlerimiz ile
banyonuza seękin bir hava
katıyoruz...

Klasik ya da modern her türlü banyoya kolaylıkla uyum sağlayabilen řıklıktaki duř setlerimiz dekorasyonunuzun tamamlayıcı parçası olacak.



► **Ankastre Batarya - Duş Seti**

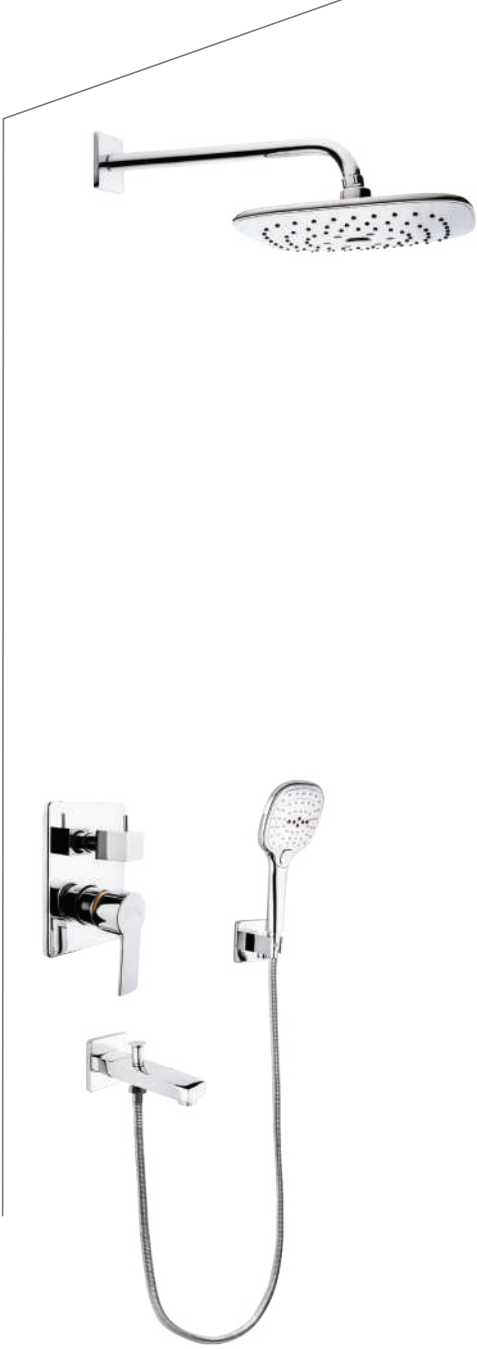

► **Defne**
Gagadan Kontrollü
Ankastre Duş Seti
(Kare - İki Yollu)
92.82.802

K. AD.: 8
2.878,00 TL

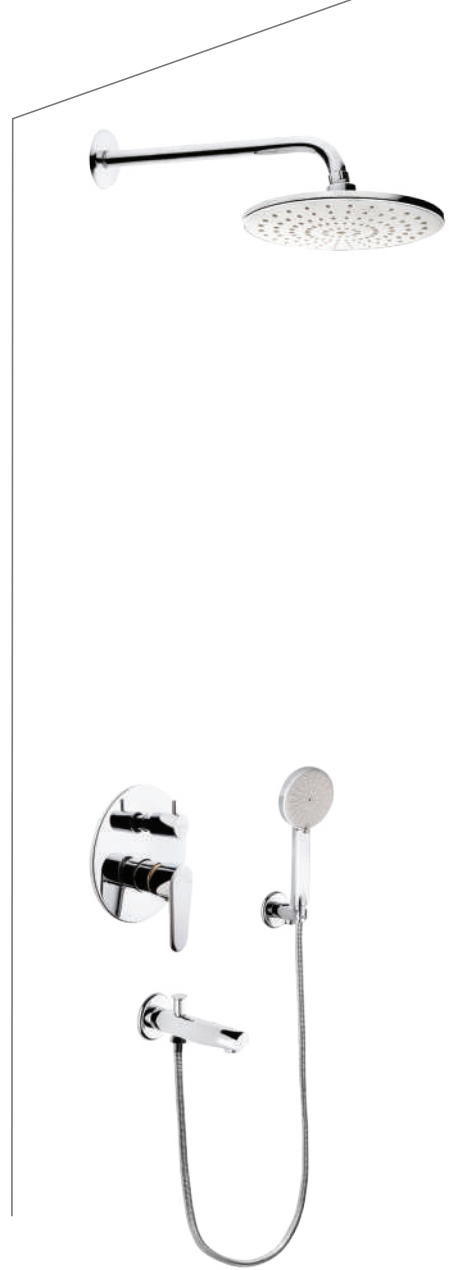

► **Arnika**
Gagadan Kontrollü
Ankastre Duş Seti
(Yuvarlak - İki Yollu)
92.82.102

K. AD.: 8
2.687,00 TL



► Ankastra Batarya - Duş Seti



► **Defne**
Kumanda Kontrollü
Ankastra Duş Seti
(Kare - Üç Yollu)
92.82.803

K. AD.: 8
3.078,00 TL

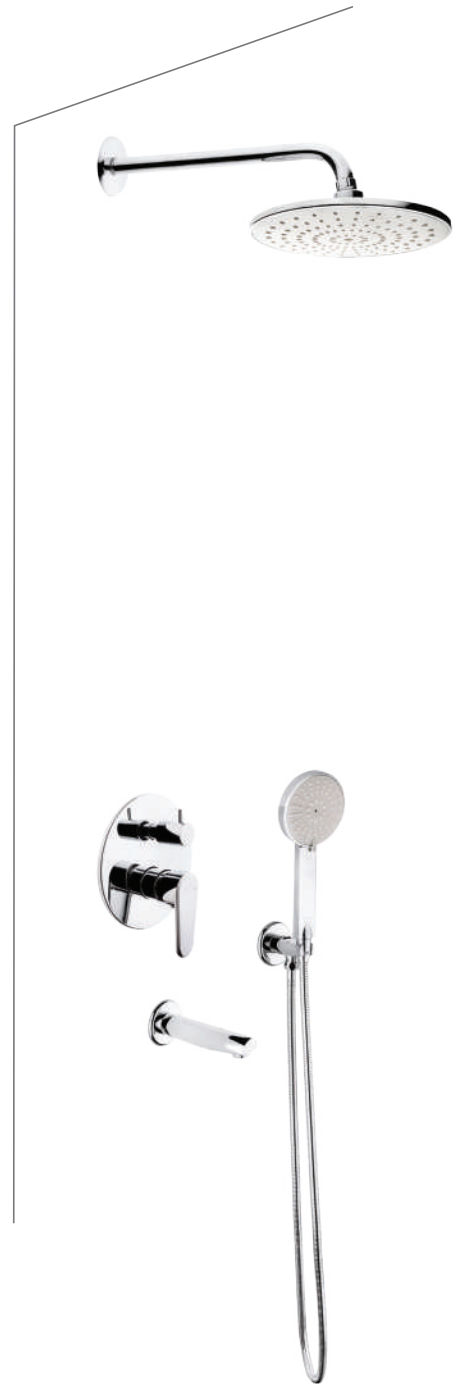

► **Arnika**
Kumanda Kontrollü
Ankastra Duş Seti
(Yuvarlak - Üç Yollu)
92.82.103

K. AD.: 8
2.852,00 TL



► **Ankastre Batarya - Duş Seti**



► **Defne**
Ankastre Duş Seti
(Kare - İki Yollu)
92.82.801

K. AD.: 8
2.728,00 TL



► **Arnika**
Ankastre Duş Seti
(Yuvarlak - İki Yollu)
92.82.101

K. AD.: 8
2.524,00 TL



► Panel Duş Seti



- **Inci**
91.30.510
K. AD.: 1
6.006,00 TL



► Tepe Duş Setleri



► Tepe Duş Setleri



► Tepe Duş Setleri



► **Elmas**
91.31.310
K. AD.: 4
1.049,00 TL

► Tepe Duş Setleri



► **Yakut**
91.31.210
 K. AD.: 4
984,00 TL

► Sürgülü Duş Setleri



- **Safir**
91.31.420
K. AD.: 12
427,00 TL



► Sürgülü Duş Setleri



► **Kuartz**
91.31.020
 K. AD.: 12
412,00 TL

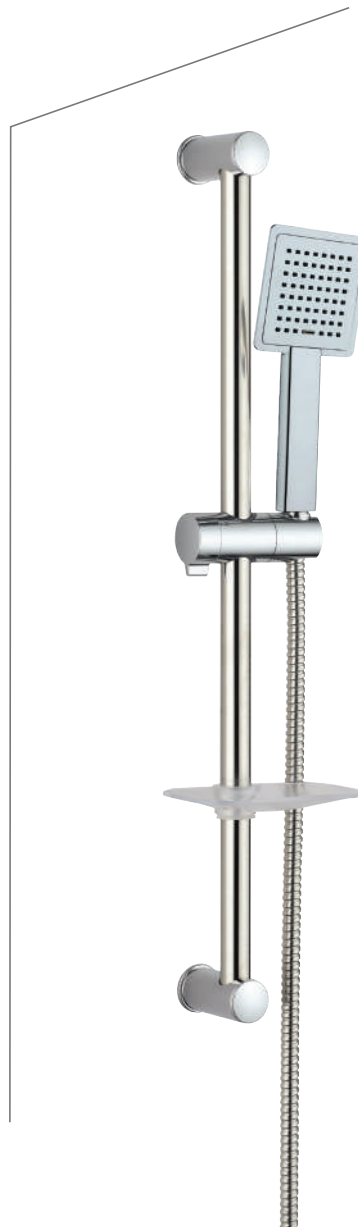

► **Elmas**
91.31.320
 K. AD.: 12
245,00 TL



► Sürgülü Duş Setleri



► **Yakut**
91.31.220
K. AD.: 12
213,00 TL

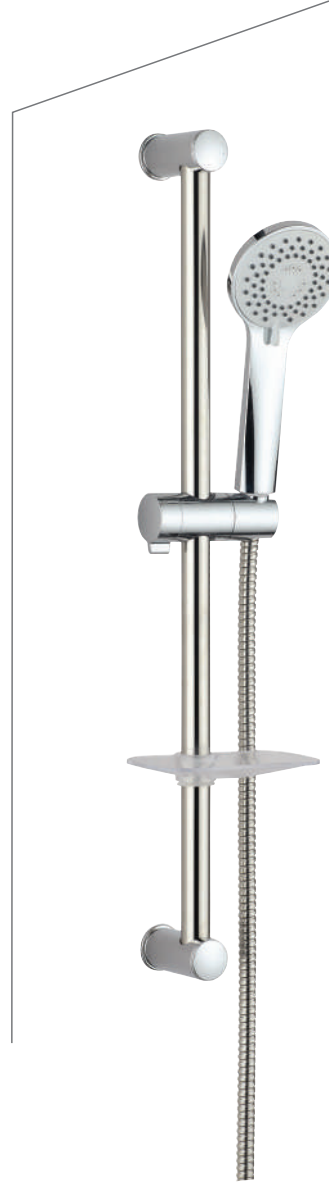

► **Zümrüt**
91.31.120
K. AD.: 12
192,00 TL

► Mafsalı Duş Setleri



► **Safir**
91.31.430
 K. AD.: 28
300,00 TL



► **Kuartz**
91.31.030
 K. AD.: 28
263,00 TL



► **Elmas**
91.31.330
 K. AD.: 28
178,00 TL



► **Yakut**
91.31.230
 K. AD.: 28
154,00 TL



► **Zümrüt**
91.31.130
 K. AD.: 28
122,00 TL

► Mafsallı Duş Setleri



- **Çok Fonksiyonlu El Tipi Duş Başlığı**
91.10.812
K. AD.: 12
202,00 TL



- **Duş Başlığı**
91.10.811
K. AD.: 18
228,00 TL



- **Kromlu Spiral Hortum - 011**
1/2" - 1/2" 150 - 180 cm
91.20.202
112,00 TL



- **Mat Spiral Hortum - 09**
1/2" - 1/2" 150 cm
91.20.200
50,60 TL

► Mafsallı Duş Setleri



► Zümrüt Duş Seti 91.31.131

K. AD.: 28
117,00 TL



► Azurit Duş Seti 91.31.531

K. AD.: 28
290,00 TL



► Lagos Duş Seti 91.31.631

K. AD.: 28
111,00 TL



► Kuartz Duş Seti 91.31.031

K. AD.: 28
259,00 TL



▶ PPRC GRUBU



Hem uygulayıcının, hem kullanıcının yanındayız.

Gönül rahatlığıyla için

KAS PPRC ürünlerinin kaygan ve parlak iç yüzeyleri sayesinde **suyun rengi ve tadı asla değişmiyor.** Folyosu ortada olduğu için kesme, tıraşlama ve **montaj süreleri maksimum düzeyde kısalıyor.**



► PPRC GRUPLARI



► Pe-Rt Boru

KOD	AÇIKLAMA	K. AD.	B. FİYATI
80.20.016	16 x 2	200	9,476 TL
80.21.016	16x2 Kılıflı ■	100	14,290 TL
80.22.016	16x2 Kılıflı ■	100	14,290 TL
80.10.016	16x2 Oksijen Bariyerli	160	11,030 TL
80.11.016	16x2 Oksijen Bar. Kılıflı ■	100	15,840 TL
80.12.016	16x2 Oksijen Bar. Kılıflı ■	100	15,840 TL



► PPRC Alüminyum Folyolu Boru (PN25)

KOD	AÇIKLAMA	K. AD.	B. FİYATI
94.11.020	20 mm	4 x 25	27,870 TL
94.11.025	25 mm	4 x 20	40,370 TL
94.11.032	32 mm	4 x 15	67,500 TL
94.11.040	40 mm	4 x 10	103,000 TL
94.11.050	50 mm	4 x 5	164,000 TL
94.11.063	63 mm	4 x 4	252,000 TL



► PPRC Boru (PN16)

KOD	AÇIKLAMA	K. AD.	B. FİYATI
94.02.020	20 mm	4 x 25	15,080 TL
94.02.025	25 mm	4 x 20	22,820 TL
94.02.032	32 mm	4 x 15	42,230 TL
94.02.040	40 mm	4 x 10	65,800 TL
94.02.050	50 mm	4 x 5	105,000 TL
94.02.063	63 mm	4 x 4	167,000 TL
94.02.075	75 mm	4 x 3	236,000 TL
94.02.090	90 mm	4 x 2	381,000 TL
94.02.110	100 mm	4 x 1	564,000 TL

► PPRC Boru (PN20)

KOD	AÇIKLAMA	K. AD.	B. FİYATI
94.03.020	20 mm	4 x 25	17,860 TL
94.03.025	25 mm	4 x 20	29,430 TL
94.03.032	32 mm	4 x 15	52,700 TL
94.03.040	40 mm	4 x 10	77,400 TL
94.03.050	50 mm	4 x 5	124,000 TL
94.03.063	63 mm	4 x 4	198,000 TL
94.03.075	75 mm	4 x 3	300,000 TL
94.03.090	90 mm	4 x 2	483,000 TL
94.03.110	110 mm	4 x 1	719,000 TL

► PPRC GRUPLARI



► PPRC Kompozit Boru (PN20)

KOD	AÇIKLAMA	K. AD.	B. FİYATI
94.06.020	20 mm	4 x 25	19,440 TL
94.06.025	25 mm	4 x 20	29,960 TL
94.06.032	32 mm	4 x 15	55,500 TL
94.06.040	40 mm	4 x 10	71,000 TL
94.06.050	50 mm	4 x 5	116,000 TL
94.06.063	63 mm	4 x 4	180,000 TL
94.06.075	75 mm	4 x 3	270,000 TL
94.06.090	90 mm	4 x 2	405,000 TL
94.06.110	110 mm	4 x 1	617,000 TL

► PPRC Kompozit Boru (PN25)

KOD	AÇIKLAMA	K. AD.	B. FİYATI
94.07.020	20 mm	4 x 25	22,990 TL
94.07.025	25 mm	4 x 20	34,310 TL
94.07.032	32 mm	4 x 15	60,200 TL
94.07.040	40 mm	4 x 10	94,700 TL
94.07.050	50 mm	4 x 5	150,000 TL
94.07.063	63 mm	4 x 4	235,000 TL
94.07.075	75 mm	4 x 3	334,000 TL
94.07.090	90 mm	4 x 2	470,000 TL
94.07.110	110 mm	4 x 1	729,000 TL



► Kuyruklu Dirsek 90°

KOD	AÇIKLAMA	K. AD.	B. FİYATI
94.13.220	20 mm	300	4,434 TL
94.13.225	25 mm	150	6,710 TL
94.13.232	32 mm	90	11,420 TL



► TE Parça

KOD	AÇIKLAMA	K. AD.	B. FİYATI
94.15.020	20 mm	240	3,116 TL
94.15.025	25 mm	150	4,074 TL
94.15.032	32 mm	75	7,401 TL
94.15.040	40 mm	50	14,170 TL
94.15.050	50 mm	30	25,880 TL
94.15.063	63 mm	16	42,060 TL
94.15.075	75 mm	10	65,200 TL
94.15.090	90 mm	5	127,000 TL
94.15.110	110 mm	2	229,000 TL

► PPRC GRUPLARI



► Inegal TE

KOD	AÇIKLAMA	K. AD.	B. FİYATI
94.16.001	25x20x20 mm	200	3,357 TL
94.16.002	25x20x25 mm	150	3,715 TL
94.16.003	32x20x20 mm	90	7,281 TL
94.16.004	32x20x32 mm	80	6,682 TL
94.16.005	32x25x20 mm	90	6,981 TL
94.16.006	32x25x25 mm	90	8,029 TL
94.16.007	32x25x32 mm	80	7,071 TL
94.16.008	40x20x40 mm	60	10,250 TL
94.16.009	40x25x40 mm	60	10,850 TL
94.16.010	40x32x40 mm	50	12,020 TL
94.16.011	50x20x50 mm	32	20,760 TL
94.16.012	50x25x50 mm	32	20,760 TL
94.16.013	50x32x50 mm	32	20,940 TL
94.16.014	50x40x50 mm	32	22,200 TL
94.16.015	63x20x63 mm	18	37,120 TL
94.16.016	63x25x63 mm	18	37,810 TL
94.16.017	63x32x63 mm	18	37,120 TL
94.16.018	63x40x63 mm	18	37,120 TL
94.16.019	63x50x63 mm	18	37,510 TL
94.16.020	75x20x75 mm	12	91,800 TL
94.16.021	75x25x75 mm	12	91,700 TL
94.16.022	75x32x75 mm	12	91,600 TL
94.16.023	75x40x75 mm	12	93,000 TL
94.16.024	75x50x75 mm	12	91,800 TL
94.16.025	75x63x75 mm	12	94,500 TL
94.16.026	90x20x90 mm	5	134,000 TL
94.16.027	90x25x90 mm	5	133,000 TL
94.16.028	90x32x90 mm	5	133,000 TL
94.16.029	90x40x90 mm	5	133,000 TL
94.16.030	90x50x90 mm	5	133,000 TL
94.16.031	90x63x90 mm	5	133,000 TL
94.16.032	90x75x90 mm	5	137,000 TL
94.16.033	110x20x110 mm	3	216,000 TL
94.16.034	110x25x110 mm	3	216,000 TL
94.16.035	110x32x110 mm	3	212,000 TL
94.16.036	110x40x110 mm	3	212,000 TL
94.16.037	110x50x110 mm	3	212,000 TL
94.16.038	110x63x110 mm	3	211,000 TL
94.16.039	110x75x110 mm	3	212,000 TL
94.16.040	110x90x110 mm	3	214,000 TL



► Redüksiyon

KOD	AÇIKLAMA	K. AD.	B. FİYATI
94.19.001	25x20 mm	600	1,469 TL
94.19.002	32x20 mm	300	2,128 TL
94.19.003	32x25 mm	300	2,337 TL
94.19.004	40x20 mm	250	4,493 TL
94.19.005	40x25 mm	200	4,434 TL
94.19.006	40x32 mm	160	5,033 TL
94.19.009	50x32 mm	125	12,100 TL
94.19.010	50x40 mm	100	12,400 TL
94.19.012	63x25 mm	80	15,070 TL
94.19.013	63x32 mm	64	14,290 TL
94.19.014	63x40 mm	64	14,980 TL
94.19.015	63x50 mm	52	18,450 TL
94.19.016	75x50 mm	30	28,910 TL
94.19.017	75x63 mm	30	32,540 TL
94.19.018	90x40 mm	20	34,540 TL
94.19.019	90x50 mm	20	36,430 TL
94.19.020	90x63 mm	20	41,310 TL
94.19.021	90x75 mm	20	44,130 TL
94.19.022	110x50 mm	20	48,890 TL
94.19.023	110x63 mm	16	70,300 TL
94.19.024	110x75 mm	16	76,300 TL
94.19.025	110x90 mm	12	85,200 TL

► PPRC GRUPLARI



► Dirsek 45°

KOD	AÇIKLAMA	K. AD.	B. FİYATI
94.14.020	20 mm	400	2,247 TL
94.14.025	25 mm	300	2,847 TL
94.14.032	32 mm	150	5,304 TL
94.14.040	40 mm	80	8,927 TL
94.14.050	50 mm	48	16,900 TL
94.14.063	63 mm	21	28,850 TL
94.14.075	75 mm	12	63,200 TL
94.14.090	90 mm	10	101,000 TL
94.14.110	110 mm	4	152,000 TL



► Dirsek 90°

KOD	AÇIKLAMA	K. AD.	B. FİYATI
94.13.020	20 mm	400	2,038 TL
94.13.025	25 mm	200	3,146 TL
94.13.032	32 mm	125	5,692 TL
94.13.040	40 mm	60	10,310 TL
94.13.050	50 mm	30	20,400 TL
94.13.063	63 mm	18	32,450 TL
94.13.075	75 mm	12	57,200 TL
94.13.090	90 mm	6	106,000 TL
94.13.110	110 mm	3	163,000 TL



► Kapama Başlığı

KOD	AÇIKLAMA	K. AD.	B. FİYATI
94.18.020	20 mm	800	1,078 TL
94.18.025	25 mm	500	1,469 TL
94.18.032	32 mm	300	2,516 TL
94.18.040	40 mm	200	5,092 TL
94.18.050	50 mm	100	18,900 TL
94.18.063	63 mm	60	23,700 TL
94.18.075	75 mm	40	29,240 TL
94.18.090	90 mm	24	41,400 TL
94.18.110	110 mm	12	79,800 TL



► Manşon

KOD	AÇIKLAMA	K. AD.	B. FİYATI
94.17.020	20 mm	600	1,410 TL
94.17.025	25 mm	300	1,976 TL
94.17.032	32 mm	200	3,357 TL
94.17.040	40 mm	100	6,503 TL
94.17.050	50 mm	80	13,120 TL
94.17.063	63 mm	36	21,720 TL
94.17.075	75 mm	24	32,290 TL
94.17.090	90 mm	12	56,400 TL
94.17.110	110 mm	4	91,100 TL

► PPRC GRUPLARI



► C Kavis

KOD	AÇIKLAMA	K. AD.	B. FİYATI
94.12.220	20 mm	120	5,005 TL
94.12.225	25 mm	120	5,724 TL
94.12.232	32 mm	60	12,160 TL



► Manşonlu Kavis

KOD	AÇIKLAMA	K. AD.	B. FİYATI
94.12.120	20 mm	60	10,700 TL
94.12.125	25 mm	60	14,080 TL
94.12.132	32 mm	40	27,080 TL



► Kavis

KOD	AÇIKLAMA	K. AD.	B. FİYATI
94.12.020	20 mm	75	8,479 TL
94.12.025	25 mm	60	13,150 TL
94.12.032	32 mm	40	19,350 TL
94.12.040	40 mm	20	31,790 TL



► Kör Tapa

KOD	AÇIKLAMA	K. AD.	B. FİYATI
94.21.001	20 mm	900	1,198 TL
94.21.002	25 mm	600	1,439 TL
94.21.003	32 mm	400	2,309 TL
94.21.011	20 mm (Uzun)	600	2,337 TL
94.21.021	20 mm	200	2,937 TL

► PPRC GRUPLARI



► İstavroz

KOD	AÇIKLAMA	K. AD.	B. FİYATI
94.31.020	20 mm	200	8,359 TL
94.31.025	25 mm	140	9,677 TL
94.31.032	32 mm	60	12,760 TL
94.31.040	40 mm	40	16,930 TL



► Çekvalf

KOD	AÇIKLAMA	K. AD.	B. FİYATI
94.33.695	20 mm	100	32,150 TL
94.33.696	25 mm	50	37,900 TL



► PPRC Düz Radyatör Vanası

KOD	AÇIKLAMA	K. AD.	B. FİYATI
94.33.700	20 mm	100	69,600 TL
94.33.701	25 mm	60	80,800 TL



► PPRC Köşe Radyatör Vanası

KOD	AÇIKLAMA	K. AD.	B. FİYATI
94.33.702	20 mm	100	70,000 TL
94.33.703	25 mm	60	81,700 TL

► PPRC GRUPLARI

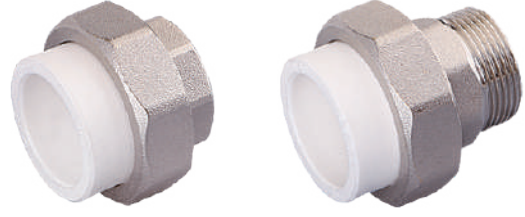
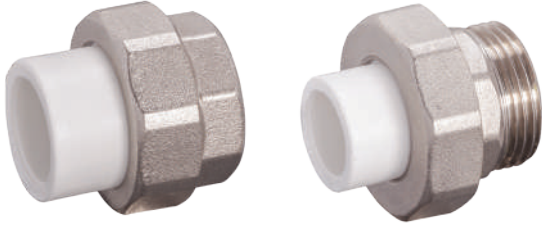

► Oynar Başlıklı Rakorlar - Kromlu

KOD	AÇIKLAMA	K. AD.	B. FİYATI
80.21.740	20x3/4" İç Dişli Rakor	200	31,310 TL
80.21.741	20x1" İç Dişli Rakor	200	56,600 TL
80.21.742	25x1/2" İç Dişli Rakor	200	48,830 TL
80.21.743	25x1" İç Dişli Rakor	150	51,100 TL
80.21.745	32x3/4" İç Dişli Rakor	100	59,200 TL
80.21.760	20x3/4" Dış Dişli Rakor	150	38,290 TL
80.21.761	20x1" Dış Dişli Rakor	200	65,900 TL
80.21.762	25x1/2" Dış Dişli Rakor	200	48,830 TL
80.21.763	25x1" Dış Dişli Rakor	100	59,200 TL
80.21.765	32x3/4" Dış Dişli Rakor	100	64,200 TL

► Oynar Başlıklı Rakorlar - Kromlu

KOD	AÇIKLAMA	K. AD.	B. FİYATI
80.21.730	1/2" İç Dişli Rakor	200	29,990 TL
80.21.731	3/4" İç Dişli Rakor	150	46,970 TL
80.21.732	1" İç Dişli Rakor	100	56,500 TL
80.21.733	1 1/4" İç Dişli Rakor	50	94,300 TL
80.21.734	1 1/2" İç Dişli Rakor	30	155,000 TL
80.21.735	2" İç Dişli Rakor	20	283,000 TL
80.21.750	1/2" Dış Dişli Rakor	200	33,880 TL
80.21.751	3/4" Dış Dişli Rakor	150	52,500 TL
80.21.752	1" Dış Dişli Rakor	100	63,500 TL
80.21.753	1 1/4" Dış Dişli Rakor	50	107,000 TL
80.21.754	1 1/2" Dış Dişli Rakor	30	177,000 TL
80.21.755	2" Dış Dişli Rakor	20	318,000 TL



► Dış Dişli Nipel

KOD	AÇIKLAMA	K. AD.	B. FİYATI
94.23.001	20 mm x 1/2"	250	19,020 TL
94.23.002	20 mm x 3/4"	160	24,660 TL
94.23.003	25 mm x 1/2"	160	20,910 TL
94.23.004	25 mm x 3/4"	160	23,580 TL
94.23.005	32 mm x 1/2"	100	24,120 TL
94.23.006	32 mm x 3/4"	100	26,600 TL
94.23.007	32 mm x 1"	100	35,890 TL
94.23.008	40 mm x 1/4"	48	98,600 TL
94.23.009	50 mm x 1/2"	42	146,000 TL
94.23.010	63 mm x 2"	24	189,000 TL
94.23.011	75 mm x 2 1/2"	8	468,000 TL
94.23.012	90 mm x 3"	6	676,000 TL
94.23.013	110 mm x 3"	3	1.062,000 TL

► İç Dişli Nipel

KOD	AÇIKLAMA	K. AD.	B. FİYATI
94.22.001	20 mm x 1/2"	300	14,770 TL
94.22.002	20 mm x 3/4"	160	21,060 TL
94.22.003	25 mm x 1/2"	160	16,810 TL
94.22.004	25 mm x 3/4"	160	21,300 TL
94.22.005	32 mm x 1/2"	100	20,040 TL
94.22.006	32 mm x 3/4"	100	24,330 TL
94.22.007	32 mm x 1"	100	28,790 TL
94.22.008	40 mm x 1/4"	48	73,600 TL
94.22.009	50 mm x 1/2"	42	89,200 TL
94.22.010	63 mm x 2"	24	150,000 TL
94.22.011	75 mm x 2 1/2"	8	418,000 TL
94.22.012	90 mm x 3"	6	637,000 TL
94.22.013	110 mm x 4"	4	845,000 TL

► PPRC GRUPLARI



► Dış Dişli Dirsek

KOD	AÇIKLAMA	K. AD.	B. FİYATI
94.25.001	20 mm x 1/2"	160	20,130 TL
94.25.002	20 mm x 3/4"	120	25,700 TL
94.25.003	25 mm x 1/2"	120	21,060 TL
94.25.004	25 mm x 3/4"	120	25,080 TL
94.25.005	32 mm x 1/2"	60	29,540 TL
94.25.006	32 mm x 3/4"	60	32,360 TL
94.25.007	32 mm x 1"	60	42,210 TL



► İç Dişli Dirsek

KOD	AÇIKLAMA	K. AD.	B. FİYATI
94.24.001	20 mm x 1/2"	240	15,550 TL
94.24.002	20 mm x 3/4"	200	21,870 TL
94.24.003	25 mm x 1/2"	120	16,990 TL
94.24.004	25 mm x 3/4"	120	22,830 TL
94.24.005	32 mm x 1/2"	60	25,440 TL
94.24.006	32 mm x 3/4"	60	29,900 TL
94.24.007	32 mm x 1"	60	34,600 TL



► Dış Dişli TE

KOD	AÇIKLAMA	K. AD.	B. FİYATI
94.27.001	20 mm x 1/2"	160	20,220 TL
94.27.002	20 mm x 3/4"	150	24,600 TL
94.27.003	25 mm x 1/2"	100	23,430 TL
94.27.004	25 mm x 3/4"	100	25,980 TL
94.27.005	32 mm x 1/2"	60	30,860 TL
94.27.006	32 mm x 3/4"	60	33,340 TL
94.27.007	32 mm x 1"	60	42,390 TL



► İç Dişli TE

KOD	AÇIKLAMA	K. AD.	B. FİYATI
94.26.001	20 mm x 1/2"	160	16,150 TL
94.26.002	20 mm x 3/4"	150	22,320 TL
94.26.003	25 mm x 1/2"	100	18,970 TL
94.26.004	25 mm x 3/4"	100	23,340 TL
94.26.005	32 mm x 1/2"	60	26,330 TL
94.26.006	32 mm x 3/4"	60	30,500 TL
94.26.007	32 mm x 1"	60	34,810 TL

► PPRC GRUPLARI



► Dış Dişli Batarya Altı

KOD	AÇIKLAMA	K. AD.	B. FİYATI
94.29.001	20 mm x 1/2"	150	20,940 TL
94.29.002	25 mm x 1/2"	120	22,590 TL
94.29.003	25 mm x 3/4"	60	25,040 TL



► İç Dişli Batarya Altı

KOD	AÇIKLAMA	K. AD.	B. FİYATI
94.28.001	20 mm x 1/2"	150	16,900 TL
94.28.002	25 mm x 1/2"	120	18,370 TL



► Oynar Başlıklı Rakor

KOD	AÇIKLAMA	K. AD.	B. FİYATI
94.30.001	20 mm x 1/2"	300	22,320 TL
94.30.002	25 mm x 3/4"	200	30,140 TL
94.30.007	32 mm x 1"	160	66,100 TL



► Oynar Başlıklı Rakor

KOD	AÇIKLAMA	K. AD.	B. FİYATI
94.30.003	20 mm x 1/2"	200	22,920 TL
94.30.004	25 mm x 3/4"	150	31,190 TL

► PPRC GRUPLARI



► Batarya Altı (Tek Hat)

KOD	AÇIKLAMA	K. AD.	B. FİYATI
94.28.006	20 mm x 1/2"	50	38,860 TL

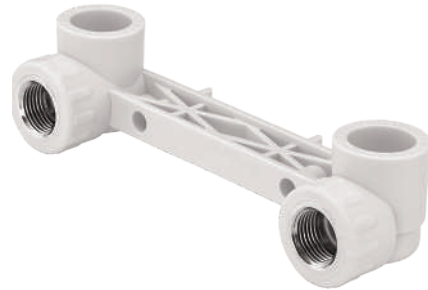

► Batarya Altı (Çift Hat)

KOD	AÇIKLAMA	K. AD.	B. FİYATI
94.28.004	20 mm x 1/2"	50	41,070 TL
94.28.005	25 mm x 1/2"	40	39,070 TL



► Kombi Bağlantı Seti

KOD	AÇIKLAMA	K. AD.	B. FİYATI
94.37.440	8'li Düz Set	20	253,000 TL
94.37.441	8'li Köşe Set	20	256,000 TL
94.37.442	10'lu Düz Set	12	325,000 TL
94.37.443	10'lu Köşe Set	12	328,000 TL



► Stop Vana

KOD	AÇIKLAMA	K. AD.	B. FİYATI
94.33.676	20 mm x 1/2"	60	60,200 TL
94.33.677	25 mm x 3/4"	50	75,100 TL
94.33.678	32 mm x 1"	30	98,400 TL

► PPRC GRUPLARI



► Küresel Vana

KOD	AÇIKLAMA	K. AD.	B. FİYATI
94.33.670	1/2"	80	33,430 TL
94.33.671	3/4"	70	39,900 TL
94.33.672	1"	60	50,100 TL
94.33.673	1 1/4"	20	98,400 TL
94.33.674	1 1/2"	10	183,000 TL
94.33.675	2"	10	332,000 TL

► Pislik Tutucu

KOD	AÇIKLAMA	K. AD.	B. FİYATI
94.33.680	1/2"	100	30,290 TL
94.33.681	3/4"	80	42,210 TL
94.33.682	1"	35	76,300 TL



► Kelepçe

KOD	AÇIKLAMA	K. AD.	B. FİYATI
94.20.020	20 mm Tekli	900	0,870 TL
94.20.025	25 mm Tekli	900	1,050 TL
94.20.032	32 mm Tekli	400	1,857 TL
94.20.040	40 mm Tekli	200	3,835 TL
94.20.220	20 mm Çiftli	400	2,217 TL
94.20.225	25 mm Çiftli	300	2,427 TL
94.20.232	32 mm Çiftli	200	3,955 TL
94.20.120	20 mm Tekli Kilitli	600	1,290 TL
94.20.125	25 mm Tekli Kilitli	600	2,009 TL
94.20.132	32 mm Tekli Kilitli	300	2,787 TL



ONLINE MÜŞTERİ HİZMETLERİ

www.kas.com.tr

Online ileti, anlık takip, kolay kullanım, hızlı sonuç.

KAS®

Evinizin her yerindeyiz!



KAYALAR PRES, AEO sertifikasına sahip bir firmadır.

KASPA DIŐ TİC. A.Ő.

Necip Fazıl Mah. Sađdıç Sok. No: 4 Ümraniye / İSTANBUL – TURKEY
Tel: +90 216 527 1 527 Fax: +90 216 499 74 76 info@kas.com.tr

    / kas grup
www.kas.com.tr